



**Instruction Manual for the
Mirror Reflex Motion Picture Camera**

ARRIFLEX 16 BL



Fig. I

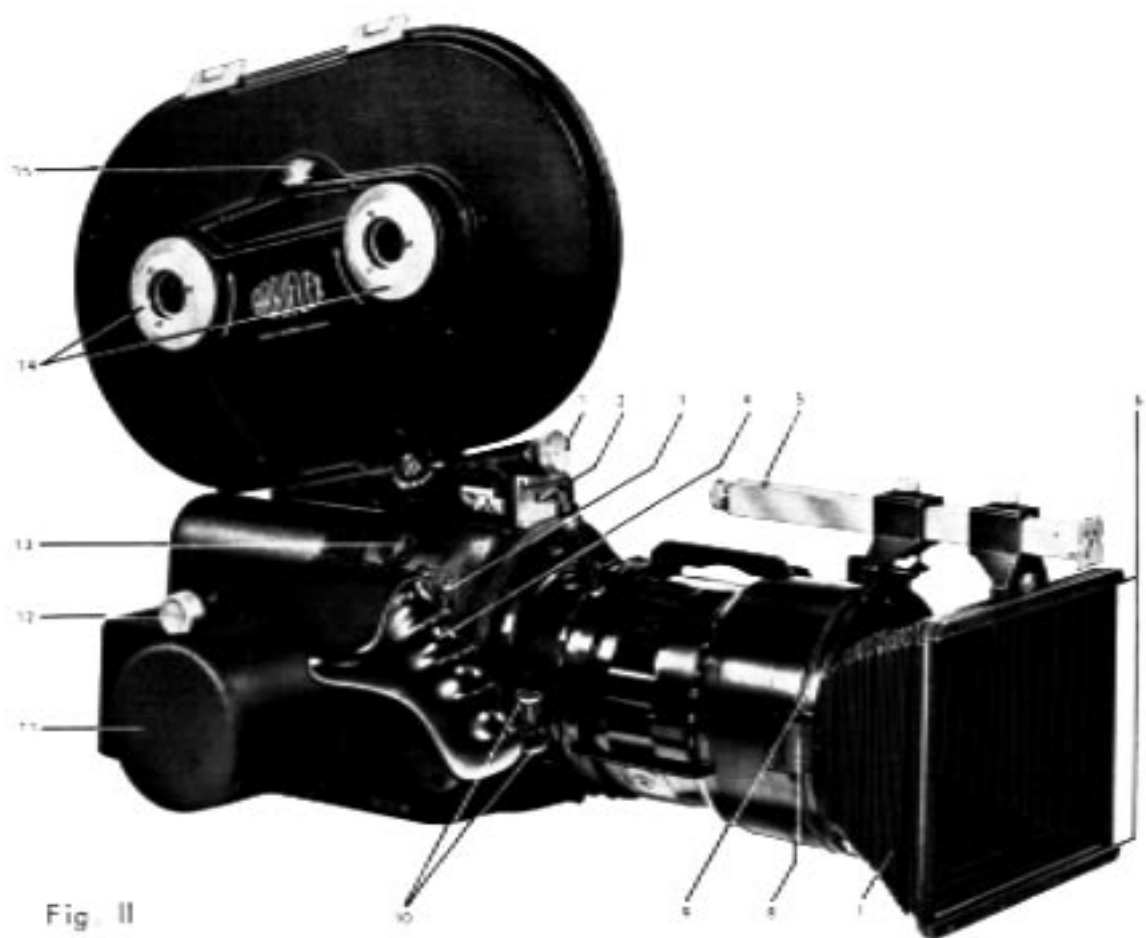
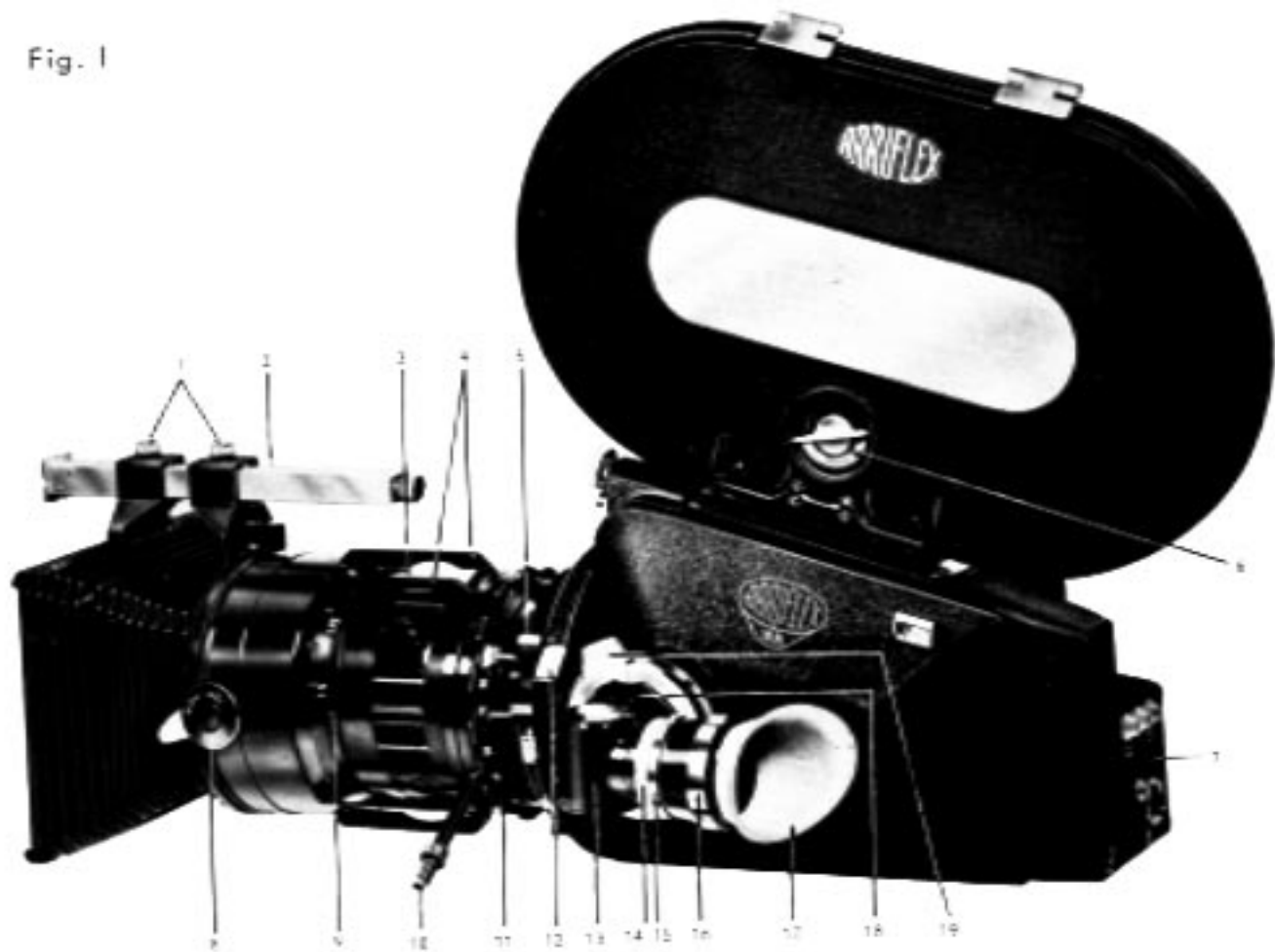

Fig. II

Fig. I

- 1 Knurled knobs for adjusting bellows
- 2 Matte box boom
- 3 Plaxiglass window
- 4 One of three focusing grips
- 5 Lock: lens housing/camera
- 6 Magazine lid lock
- 7 Exchangeable pilot tone and start marking unit
- 8 Lock to filter door
- 9 Focus index mark
- 10 Special zoom lever
- 11 Focal length adjustment ring
- 12 Push button to unlock lens
- 13 Short periscopic viewfinder
- 14 Collar for mounting eyepiece
- 15 Knurled ring for locking diopter adjustment
- 16 Diopter adjustment ring
- 17 Rubber eyecup
- 18 Lock to periscopic viewfinder
- 19 Camera door lock

Fig. II

- 1 Magazine lock
- 2 Accessory shoe
- 3 Release
- 4 Hand grip
- 5 Matte box boom
- 6 Effects mask mounting
- 7 Matte box bellows
- 8 Hinge to filter door
- 9 Filter holder
- 10 Diaphragm adjustment grips
- 11 Camera motor cap
- 12 Zero re-set for footage counter
- 13 Film plane mark
- 14 Knurled disks for tightening film slack
- 15 Film supply indicator

Construction and Design

The ARRIFLEX 16 BL is a noiseless 16 mm mirror reflex newsreel camera with electric drive. In order to maintain the excellent technical features of the proven ARRIFLEX models 16 St and 16 M (such as the precision film registration pin, forward and reverse operation, tachometer, footage indicator, interchangeable motors, mirror reflex system, etc.), achieve a low noise level and avoid excess weight, this new camera has been built with a fully sound-proofed construction in which all components which produce or conduct noise have been insulated within or upon the camera body. This applies to the camera mechanism complete with the film transport system, the interchangeable motors, the lens, the viewfinder system, and the magazines. This construction makes the ARRIFLEX 16 BL an extremely versatile, noiseless, and relatively light-weight newsreel camera which can be used equally well whether mounted upon a tripod or hand-held, with or without a shoulder support. Taking today's highly advanced zoom lenses into consideration, the ARRIFLEX 16 BL has been constructed with only one lens mount especially designed for the use of zoom lenses although normal lenses may also be used. The lenses can be exchanged quite easily. The ARRIFLEX 16 BL works with quick-changing magazines with built-in feed and take-up mechanisms. The film transport is the same as in the ARRIFLEX 16 St and 16 M, having a precision registration pin for forward and reverse operation. The viewfinder system is different in some respects from other ARRIFLEX 16 models, the most important difference being the relocation of the ground glass in the forward focal plane. The ARRIFLEX 16 BL is operated in the same manner as the ARRIFLEX 16 M, with the exception of the following changes:

The operating controls normally firmly coupled with the camera mechanism are insulated in the ARRIFLEX 16 BL to prevent noise from being conducted from the camera interior. This applies to the lens controls for focus (I/4), focal length (I/10 a. II), diaphragm (II/10), inching knob (III/1), re-set for the footage indicator (III/4), and the two knurled disks (II/14) for taking up film slack in the magazine. The three lens controls are connected to the lens by means of rubber elements. The latter four control knobs mentioned above are completely disengaged and must be pressed in to couple them with the gears of the camera mechanism. Important! Never use the inching knob (III/1) while the camera motor is running!

1. The interchangeable sound-proofed lenses of the ARRIFLEX 16 BL

The lenses for the ARRIFLEX 16 BL are contained in a separate insulated housing and can be exchanged quickly. The lens and outer housing form a single unit, even though each connects separately with the camera. The lens is locked inside the camera whereas the housing is locked on the front of the camera.

In Figs. I and II the operating controls of the lens are shown:

- focusing adjustment V/4
- focal length (zoom) adjustment I/10 a. I/11
- diaphragm adjustment II/10

The plexiglass window on the housing (I/3) enables reading of the original lens scales. For focusing, focal length, and diaphragm, additional scales are located on the adjustment rings of the housing and can be read off at the index marks on the side by the camera assistant. The adjustment rings have handy grips for easy operation. For comfortable adjustment of the zoom range, a detachable lever (I/10) has been added. This lever is screwed into a separate ring which fits loosely over the focal length adjustment ring and can be brought into any desired position. When the zoom lever has been screwed in, the counter sleeve is left loose and the outer ring and zoom adjustment ring are brought into the desired position. The counter sleeve of the zoom lever is then screwed tight, whereby one makes certain that the rings are firmly locked together. The lens' outer housing is equipped with a hinge (II/8) so that the front part becomes a door (V/3) for the filter holder (V/9). A knurled tension lock, which catches automatically and can be tightened, presses the filter holder against an elastic sound-insulation support. To change the filter or plane glass (V/10), the lock is turned counter-clockwise and the hinged front (V/3) is opened so that the interchangeable filter holder (V/9) can be taken out. The filter holder contains the filter or plane glass (V/10) mounted upon an elastic support and retained by four leaf springs. To change filters, the upper and lower parts of the filter holder (V/9) are turned against each other until the two square cut-outs match. The filter is taken out, a new one put in, and the process reversed. Important: If square filters of up to 5 mm thickness are used, the knurled upper part is to be turned against the lower part in a clockwise direction. If filters thicker than 5 mm are used, the upper part is turned in a counter-clockwise direction to avoid damaging the leaf springs. When no filter is mounted, the plane glass of the same size must be used. The filter and the plane glass, however, can never be used together. The adjustable matte box with bellows (II/7) is mounted upon the hinged front (V/3) by seating it at the lugs (V/1) and locking it with the snap catch (V/2). The matte box swings with the hinged front (V/3) when it is opened.

A zoom lens consists of a stationary main lens and an adjustable system of auxiliary lenses. The latter system is usually of considerable length so that the front lens, because of this, enters into the focusing range of the main lens. This is especially the case with short focal length settings and small apertures. For this reason, the front lenses must always be kept especially clean, as foreign particles could easily show up in the picture. The same applies to the plane glass and the filter.

A. Removal of the sound-proofed lens

The lock of the outer housing is opened by turning the locking grip (I/5) counter-clockwise from position FIST to position LOSE. Then the push button (I/12 a. V/16) is pressed in with the index finger of the right hand and the sound-proofed lens turned counter-clockwise with the left hand until it disengages and can be slid out.

B. Mounting the sound-proofed lens

The mark LOSE on the lock of the outer housing (I/5) is matched with the red dot. The sound-proofed lens is taken in the left hand, plexiglass window up (I/3), and slid with the lens mount and its bayonet catch into the grooves of the lens socket (V/14) and turned clockwise until it engages, this being indicated by a slight click. The push button (I/12 a. V/16) need not be depressed while mounting the lens. Once the lens is locked, the outer housing (V/6) is locked by turning the ring clockwise from LOOSE to FIX.

2. Universal Lens Blimp for ARRIFLEX 16 BL



Fig. 1

In conjunction with the Universal Lens Blimp, the following lenses of fixed focal length from the ARRI Lens Programme can be used for sound-insulated shooting:

Schneider Cinegon	f / 1.8 / 10 mm (as from 1967)
Cine-Xenon	f / 2 / 28 mm
Cine-Xenon	f / 2 / 35 mm
Cine-Xenon	f / 2 / 40 mm
Cine-Xenon	f / 2 / 50 mm
Cine-Xenon	f / 2 / 75 mm
Zeiss Distagon	f / 2 / 8 mm
Distagon	f / 2 / 16 mm
Distagon	f / 2 / 24 mm
Planar	f / 2 / 32 mm
Planar	f / 2 / 50 mm
Planar	f / 2 / 85 mm
Sonnar	f / 2 / 85 mm
Cooke Speed Panchro	T / 2.2 / 25 mm
Speed Panchro	T / 2.3 / 32 mm
Speed Panchro	T / 2.3 / 40 mm
Speed Panchro	T / 2.3 / 50 mm
Speed Panchro	T / 2.3 / 75 mm

For various reasons all other lenses in the ARRI Lens Programme cannot be used with the lens blimp, or only with limitations.

1. The following lenses:

Schneider Cinegon	f / 1.8 / 18 mm
Cinegon-Xenon	f / 2 / 100 mm
Zeiss Sonnar	f / 4 / 135 mm
Cooke Speed Panchro	T / 2.2 / 18 mm
Speed Panchro	T / 2.8 / 100 mm
Kilfitt Makro-Kilar	f / 2.8 / 40 mm
Makro-Kilar	f / 2.8 / 90 mm

fit the lens mounting of the ARRIFLEX 16 BL, but will not fit into the Universal Lens Blimp, because in some cases their diameter and in others their overall length are too big. These lenses should therefore be used only when sound-insulation requirements are not critical. Moreover, lenses with a focal length in excess of 100 mm need a lens support (in preparation).

2. The fixed-focal-length lenses not listed above have too short a back focal distance (distance from rear element to mirror reflex position). This point will be taken into account in future lens designs so that all new models included in the ARRI Lens Programme will also be adapted to the ARRIFLEX 16 BL.

The Universal Lens Blimp is dimensioned so that, in principle, standard 75 x 75 mm ARRI filters and 3 x 3" Wrattenfilters can be used. These standard filters are large enough for the shortest focal length used. In view of the short focal lengths, however, filter size is governed by the overall length of the Universal Lens Blimp and hence by the maximum length of the lenses used.

The filter holders for the two zoom lenses, Angénieux Multifocus 10 x 12 and Zeiss Vario-Sonnar 6 x 12.5, are the same as those for the Universal Lens Blimp and can therefore be used interchangeably. We recommend the use of a separate holder for each filter. This makes it considerably easier to keep the filter glasses clean.

The matte box for the Universal Lens Blimp can also be used for the above-mentioned blimped zoom lenses. As from mid-1967, we will be supplying the same matte box for these lenses as for the Universal Lens Blimp. The difference from their predecessors is a mirror-holder hinge on the front frame. On request, we supply for the Universal Lens Blimp a rectangular mirror which permits indirect reading of the focusing aperture scales from a longer distance.

The length of the matte box booms is adapted to the blimped lenses. For the Universal Lens Blimp only the short boom should be used. There are no engraved bellows extension markings, as the focal lengths of the usable lenses vary.

We deliver lenses ordered for the Universal Lens Blimp ready for installation, i.e. with adjusted coupling elements and calibrated focusing aperture scales, as is the usual practice for the big studio blimps.

If already available lenses (see list on page 4) are to be used in the Universal Lens Blimp, coupling modifications and calibration of the focusing aperture scale are necessary. This can be done either by ARNOLD & RICHTER or in an authorized service workshop. Precise installation and adjustment instructions are available on request.

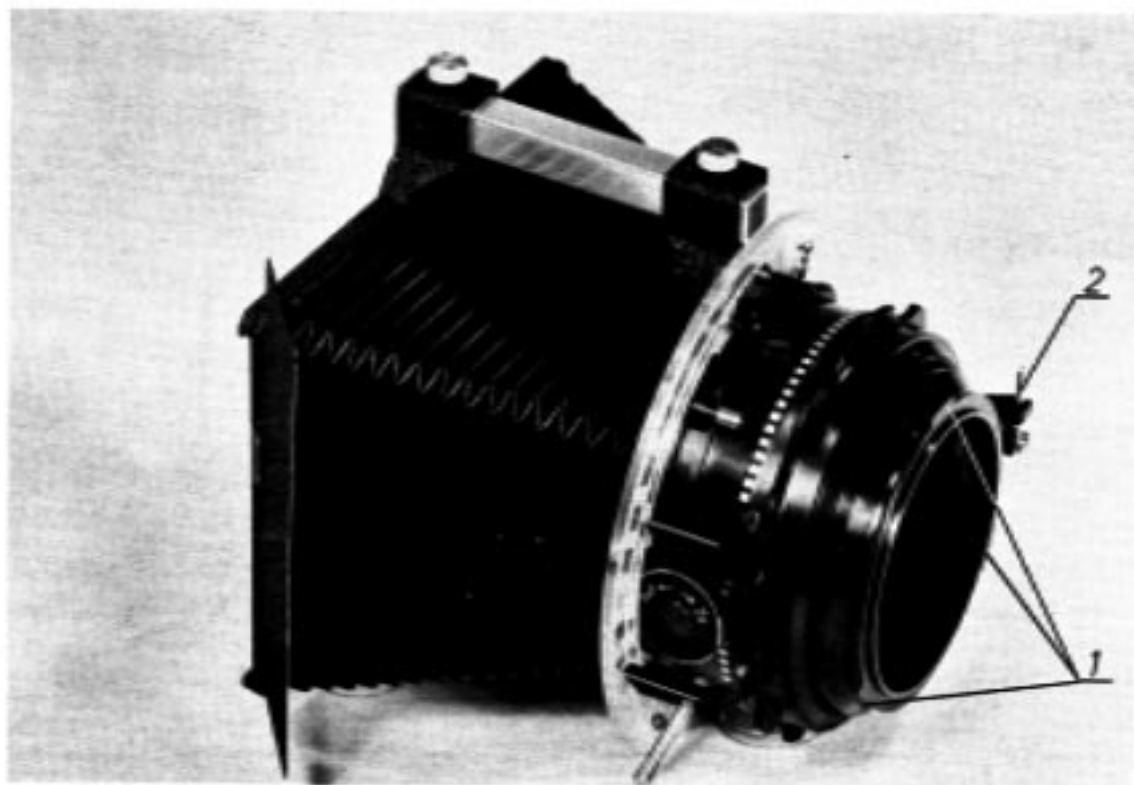

Fig. 2

1. Universal Lens Blimp, Fig. 2, with the three clamping lugs (Fig. 2/1) in the three grooves on the camera (as for zoom lens), then turn to right until the lens blimp engages the latch (Fig. 2/2). The matte box is mounted exactly as on zoom lenses.

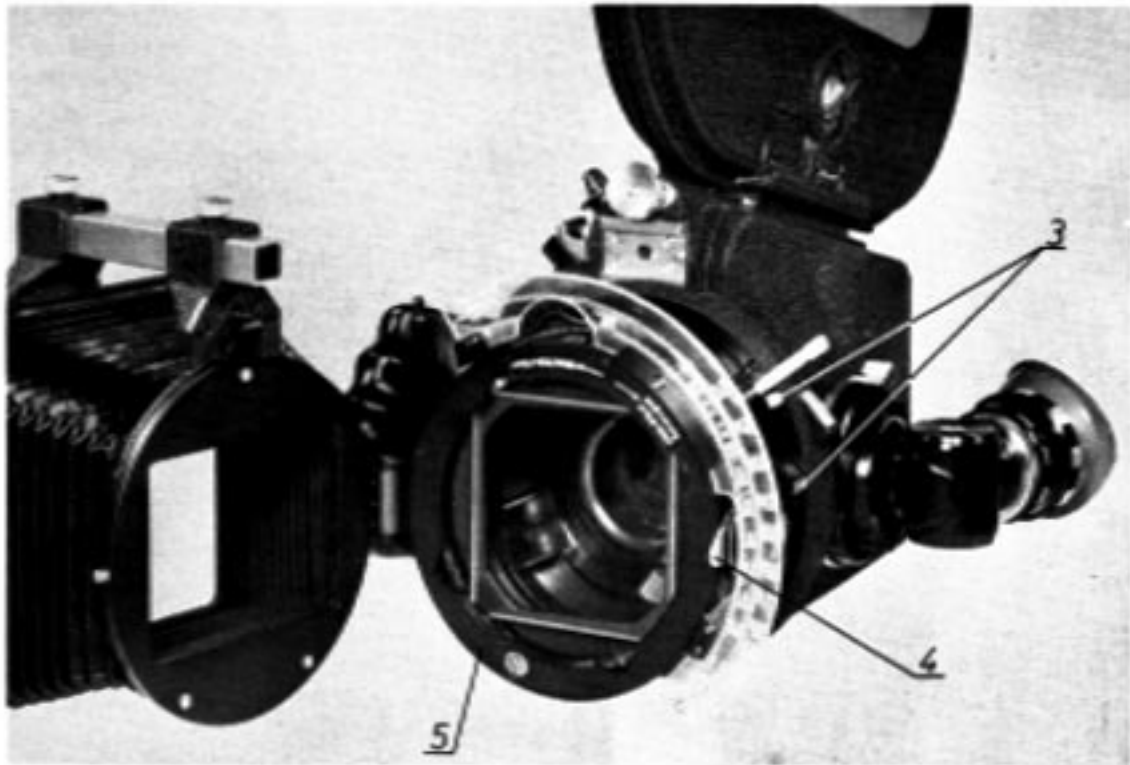

Fig. 3

II. Turn the locking ring (Fig. 3/3) to give a firm seating, loosen the closure of the front door (Fig. 3/4), open the hinged door and remove the filter holder (Fig. 3/5). Set focusing lever at 00, and swing out diaphragm driver (Fig. 4/7).

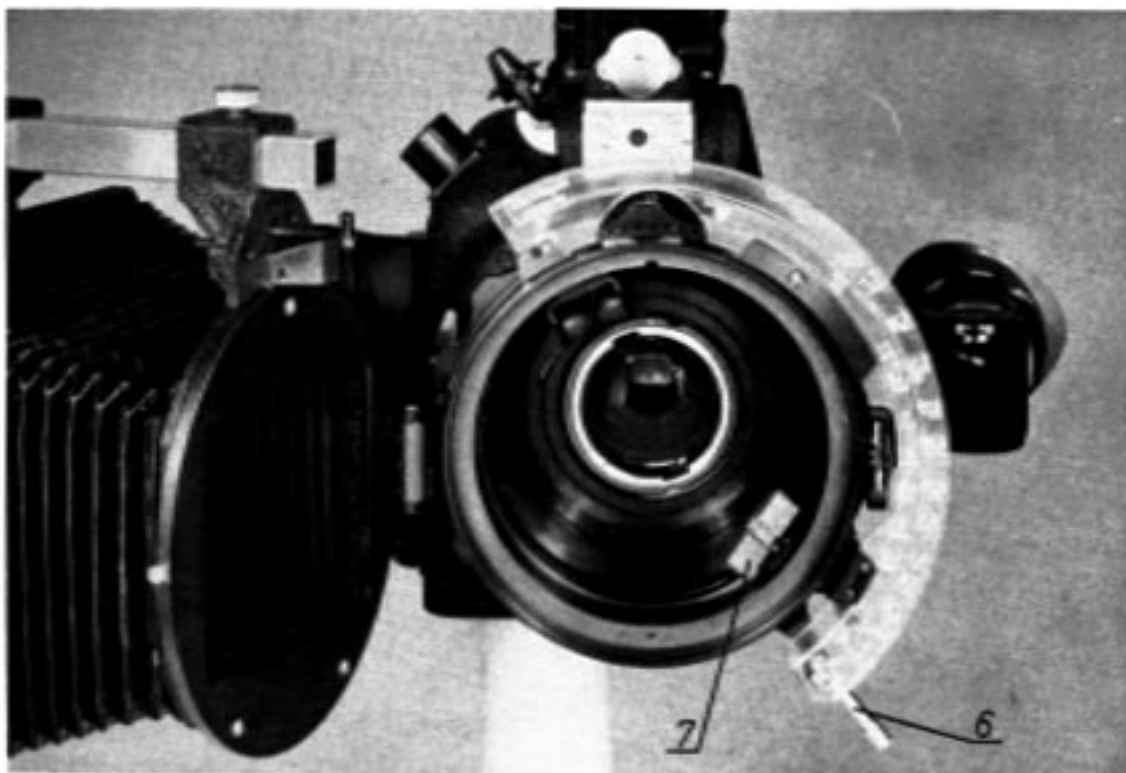

Fig. 4



III. Turn lens focusing ring (Fig. 5/8) to ∞ mark, so that the middle of the retaining pin slot (Fig. 5/9) is opposite ∞ with the ring up against the stop.

Fig. 5

IV. Open the catches for locking the lens by depressing the push button (Fig. 6/10), and insert the lens in the bore with the retaining pin slot (Fig. 5/9) uppermost. The focusing driver (Fig. 6/11) of the lens blimp engages the left leaf (in Fig. 6) of the focusing lever on the lens. The bracket makes coupling with the wrong leaf (on the right in Fig. 6) of the lens focusing lever impossible. Swing diaphragm driver back into place and couple with the diaphragm ring (Fig. 6/12).

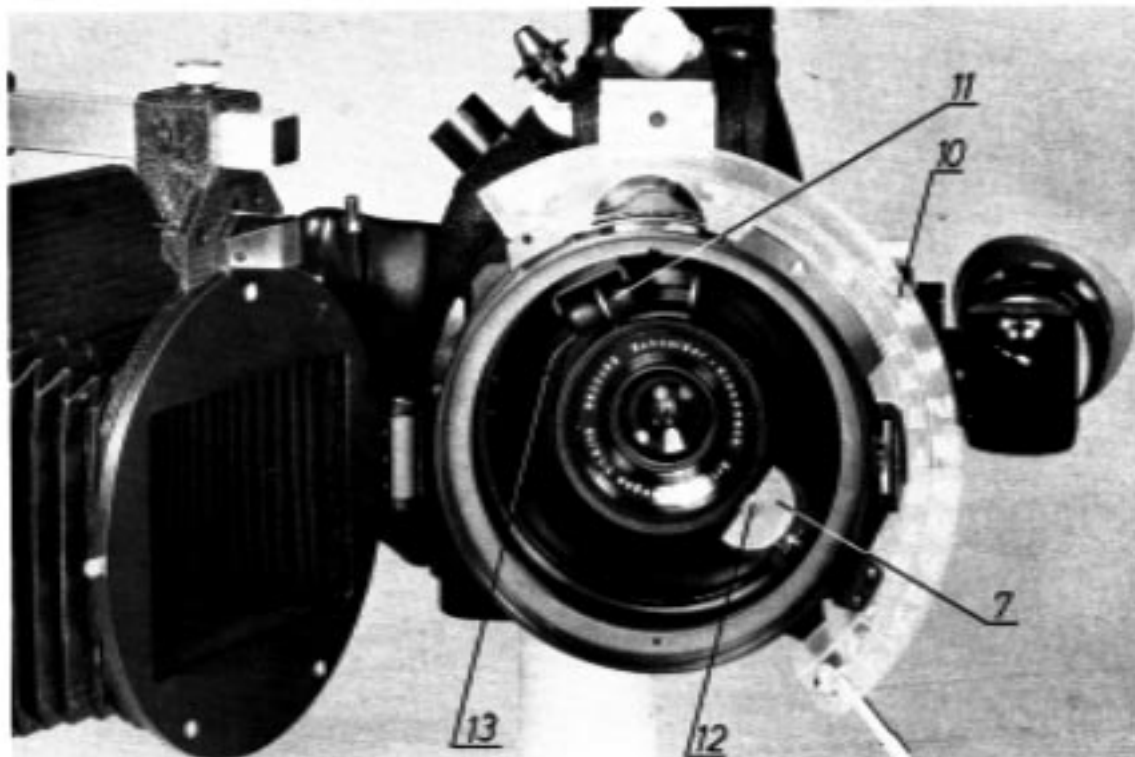

Fig. 6

V. Insert the filter holder (Fig. 3/5) and close the front door (as for zoom lenses).

VI. The focusing aperture scale (Fig. 7/13) is attached by slipping it over the pin (Fig. 7/14) and then pivoting the scale into the slot of the guide elements until it engages the catch pin (Fig. 7/16). To remove or replace the scale, the catch pin (Fig. 7/16) is pulled out.

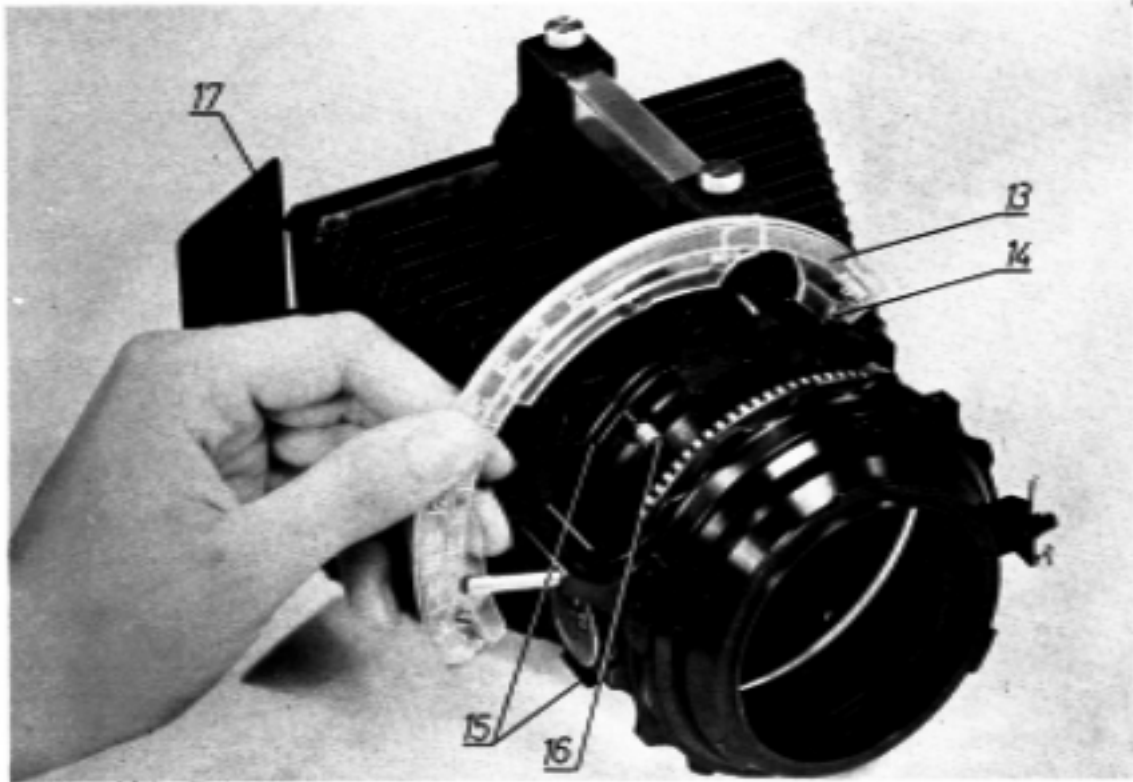

Fig. 7

VII. The interchangeable mirror (Fig. 7/17) permits indirect reading of the focusing aperture scale (Fig. 7/13) from a greater distance.

VIII. To remove the lens, reverse the above procedure.

3. The mirror reflex viewfinder system

In contrast to the previous models of the ARRIFLEX 16, the ARRIFLEX 16 BL has its ground glass (IV/6) at the front as does the ARRIFLEX 35. The ground glass area surrounding the format markings is somewhat darker than the format itself. In this manner objects located outside of the picture being filmed can also be seen. The ground glass holder is fastened with two screws (IV/7) parallel to the ground glass plane. Two precision adjusted bolts guarantee that the film and ground glass images are equal and free of parallax. This enables the ground glass holder with the ground glass to be easily exchanged for others with different formats without losing the adjustment. The viewfinder assembly is built into the camera door and the image is observed through the eyepiece. A short periscopic viewer attachment is located between the ground glass and the eyepiece. This attachment, can be turned and swivelled and locks in the operating position. By turning the lock (I/18) in a counter-clockwise direction, the short periscopic viewfinder together with the eyepiece can be removed and exchanged for the angular viewfinder (Cat.No. 1633). With this angular viewfinder attachment the eyepiece is further forward, thus granting a more favourable weight distribution for hand-held shots, as the camera may be supported against the shoulder. The viewfinder eyepiece itself is detachable as on other ARRIFLEX 16 cameras (I/14) with the only difference from previous standard eyepieces being that it is equipped with an automatic light sealing device. This is necessary because of the viewfinder construction of the ARRIFLEX 16 BL. The light closure mechanism opens automatically when the eye is pressed against the eyecup. The adjustable rubber eyecup (I/17) is detachable and can be removed by simply pulling it to the rear. When the eyecup is removed, a knurled ring becomes visible which, when turned in a clockwise direction, locks the automatic light closure mechanism at an open position. This arrangement is especially practical for hand-held shots (from a moving automobile, etc.) during which it is difficult to hold the camera steady. The light closure mechanism can be returned to automatic functioning by turning the knurled ring back in a counter-clockwise direction. The detachable rubber eyecup offers the additional advantage that each cameraman - especially if he wears glasses - can use his own eyecup. At the rear of the eyecup a centered recess is provided for the mounting of a prescription lens by an optician. As the rubber eyecup is made to fit the eye anatomically, lenses for correcting astigmatism can be mounted in the correct position.

The viewfinder eyepiece is focused with the knurled focusing ring (I/16). The focus is held with the knurled locking ring (I/16) which has the setting FEST (tight) and LOSE (loose) engraved upon it (see also the leaflet T1 E 01 101 "Interchangeable Viewfinder Eyepiece for ARRIFLEX Motion Picture Cameras").

4. The Periscope Finder for the ARRIFLEX 16 BL and its advantages over the standard viewfinder.



Fig. 1

To give the self-blimped ARRIFLEX 16 BL even greater versatility, especially for news work, tripodless operation has been made possible by equipment that holds the camera firmly on the cameraman's shoulder. This has been achieved by favourable displacement of the centre of gravity and also of the viewfinder eyepiece. The right hand on the hand grip operates the release, and the left hand sets the focus, focal length and iris diaphragm. This ensures a steady camera even for long, hand-held shooting.

In addition, as from serial No. 50701 the viewfinder mounting of the ARRIFLEX 16 BL has been modified so that in a few seconds the standard viewfinder can be removed and replaced by a newly developed periscope finder attachment that enables the ARRIFLEX 16 BL to be operated from the shoulder.

The new viewfinder mounting is constructed as a quick-change mounting integral with the camera door lock. The viewfinder in use is held firmly in this quick-change mounting by three movable, centrally arranged nylon clamp jaws and is prevented from turning by a spring-loaded locking pin.

To change the viewfinder, the black knurled ring (Fig. 2/1) is turned anti-clockwise as far as it will go. The finder can then be removed with a slight

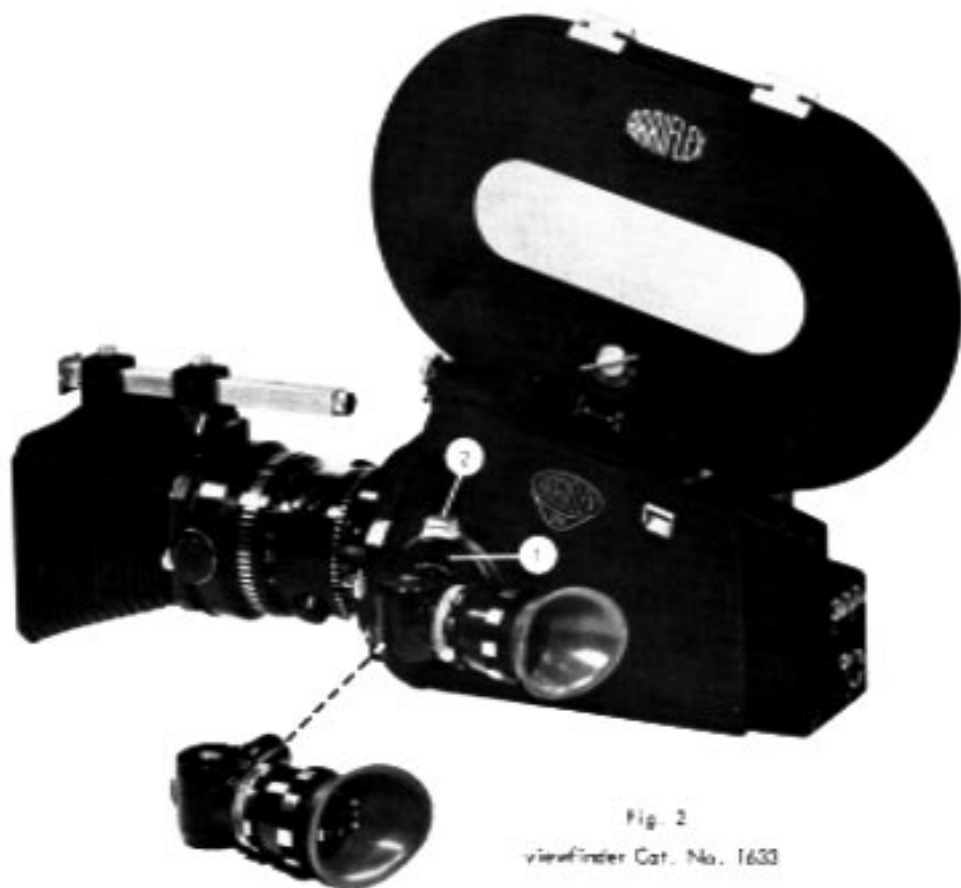

Fig. 2
viewfinder Cat. No. 1633



Fig. 3
Periscope Finder Cat. No. 1632

twisting motion, and another finder inserted by reversing this procedure. Care must be taken to ensure that the knurled ring is really turned right to the stop so that the nylon clamping jaws and the locking pin are completely retracted to prevent damage when changing finders.

When inserting the finder, it must be pushed in as far as it will go and the knurled ring firmly tightened in a clockwise direction. The finder is then turned to the operating position, where it will automatically snap into the locked position; the knurled ring should then be retightened.

One and the same eyepiece, which is removed in the usual way, can be used for both finders. This possibility of fitting both finders with one eyepiece simplifies interchanging. The most comfortable viewing position for the cameraman can be found by swivelling the eyepiece.

The glass element built into the camera door is part of the finder system. For occasional cleaning this element and its mount can be screwed out of the inside of the camera door. Replace carefully after cleaning.

In the course of redesigning the quick-change finder mounting, which, as already mentioned, forms an integral unit with the camera door lock, the door lock was also improved. In place of the former knurled locking ring, a knurled locking lug now makes opening the camera door easier.

In conclusion, we must emphasize that neither the periscope finder attachment nor the standard viewfinder should be used as a hold for carrying the camera.

D. Closing the magazines

The lid of the 400 ft. (120 m) BL magazine is shut and locked by turning the lock until the arc-sharped safety spring catches and makes the magazine light-proof.

E. Taking up film slack in the magazines

If the camera has been transported with a mounted magazine, or a new magazine is to be mounted, film in the magazine should be tightened before filming. The two knurled disks at the rear of the magazine (II/14) are pressed in and turned in the direction of the arrows until resistance of the film shows that the slack has been taken up, thus guaranteeing smooth operation of the camera.

F. Removing exposed film from the magazines

The clamping lever in the collapsible take-up core is released, freeing the film end and causing the diameter of the core to reduce considerably so that the film roll can be easily taken out. A normal plastic core is then placed into the film roll.

G. Attaching the film loop protector

To avoid possible damage to the film loop while the magazine is not mounted upon the camera, we recommend the use of the loop protector which can be quickly attached and detached at the throat of the magazine. To attach the loop protector the film is pressed gently against the magazine throat and the protector is slid over the film into the gap between the magazine throat and the retaining plate.

H. Mounting the magazines upon the camera

The magazine is placed with the rear end of its dovetail base (V/7) into the rear dovetail recess of the camera. To ensure correct meshing of the gears, gently rotate the camera gears with the inching knob (II/1) before carefully lowering the magazine at the front. Important! The inching knob must never be used while the camera motor is switched on! The knurled knob (II/1) of the open magazine lock is pressed home and turned clockwise to lock the magazine firmly.

I. Removing the magazines

The knurled knob (II/1) is turned counter-clockwise to the stop and drawn back. The magazine can then (provided that the film in the camera has been removed from the film gate) be lifted easily by tilting it backwards.

6. Drive and power supply for the camera

The interchangeable motor has a general speed of 3000 RPM, no matter whether the governor controlled DC motor or the synchronous motor is used, whether the camera is operated at 25 or 24 f.p.s.. The frame speed difference between 25 and 24 f.p.s. is attained by exchanging a pair of gears. In exchanging motors, there is only a choice between governor controlled or synchronous electric drive. The pilot tone generator is connected directly to the motor shaft so that the pilot frequency remains constant at 50 cycles whether the camera is operated at 25 or 24 f.p.s.. For countries with a standard frequency of 60 cycles where a pilot tone frequency of 60 cycles and a film speed of 24 f.p.s. are usually used because of the fact that the motor speed depends upon the frequency of the current and the fact that the pilot tone generator is connected to the motor shaft, motors with pilot tone generators for 60 cycles and 3600 RPM are available. The DC motor is designed for a standard rated voltage of 12 V. The governor controlled motor is transistorized. The ARRIFLEX 16 BL is usually driven by this motor which is fed from a 12 V battery and can be set for forward and reverse drive (III/5). One control lamp (the middle one under the plexiglass cover (III/12) at the rear of the camera) is a blinking signal light. As with all other ARRIFLEX camera types, the correct polarity is important when using the governor controlled DC motor. The plugs on both ends (V/20 a. V/21) of the power cable are of special design so that the operator of the ARRIFLEX 16 BL need pay no special attention to polarity provided that original ARRI power cables and the proper batteries are used and that the installation has not been tampered with.

A. Starting the camera

The camera can be switched on at three different points. When using the tripod or for hand-held shots without the pistol grip screwed into the tripod socket the front switch at the handgrip on the side of the camera is used. Upon being pressed this switch locks itself automatically for continuous filming. By pressing the switch again and releasing it, the camera is turned off. During news-reel shots with the shoulder support and handgrip or with the pistol grip alone, the camera is turned on by using the switch on the pistol grip in the same way as with other ARRIFLEX 16 cameras (the switch operates through the tripod socket). The ARRIFLEX 16 BL has two tripod sockets. The front one is best used for the pistol grip and shoulder support, whereas the socket at the middle of the camera bottom is usually used for tripod shots although the pistol grip could also be screwed in and used to operate the camera from this socket.

B. The changing of the film speed

between 24 and 25 f.p.s. is accomplished by exchanging the transfer gear (IV/1) and the motor pinion (IV/2) for others with a different number of teeth. To avoid error the transfer gears and motor pinions have been engraved as follows: 25 B/s 50 Hz (25 f.p.s. 50 c.p.s.); 24 B/s 50 Hz (24 f.p.s. 50 c.p.s.); and 24 B/s 60 Hz (24 f.p.s. 60 c.p.s.). The plexiglass cover of the protruding gears is removed. The motor pinion (IV/2) which is centered upon the motor shaft is unscrewed (while the transfer gear is held fast to keep the motor shaft from turning) and then lifted off. Then the transfer gear is unscrewed (again, it must be held fast to keep the camera drive from being turned) and lifted off. The mounting and tightening of a new pair of gear wheels is accomplished in reverse order. As the drive motors for the ARRIFLEX 16 BL are rather strong, in case of jamming of the film transport the camera has a built-in overload protection in the form of a torque limiter located between the camera drive and the transfer wheel driven by the motor pinion.

C. To exchange the drive motor

with another the following must be observed: The plexiglass guard for the protruding gears is removed. The motor pinion (IV/2) which is centered upon the motor shaft is unscrewed while the transfer gear is held fast (to prevent turning the motor shaft) and then lifted off. The sound-proof cover over the driving motor is attached to the camera housing with four screws. After these screws are removed the sound-proof cover can be lifted off. The driving motor is attached with three long, permanently mounted screws (IV/3). With the camera door open these screws can be easily loosened and the motor drawn out of its centering in the mounting plate whereby its connection releases itself automatically. This new motor is mounted in reverse order.

8. Single System Magnetic Sound Recording

To cater to the requirements of those who want maximum speed and as far as possible one-man camera operation for news work, we have developed a magnetic single system recording unit for the 16 BL camera.



Figure 1

Figure 1 shows the 16 BL camera ready for operation with the built-in magnetic single system recording unit, now available as a complete picture/sound camera. All cameras from No. 50 170 can be converted without any special modifications in any good service workshop equipped for sound measurements. Obviously the 16 BL camera with magnetic single system unit must not be run backwards, or the film will most certainly tear. Supplementary parts ordered to convert 16 BL cameras from No. 50 170 onwards are accompanied by installation instructions.

All parts required for conversion to magnetic single system recording are shown in Fig. 2.

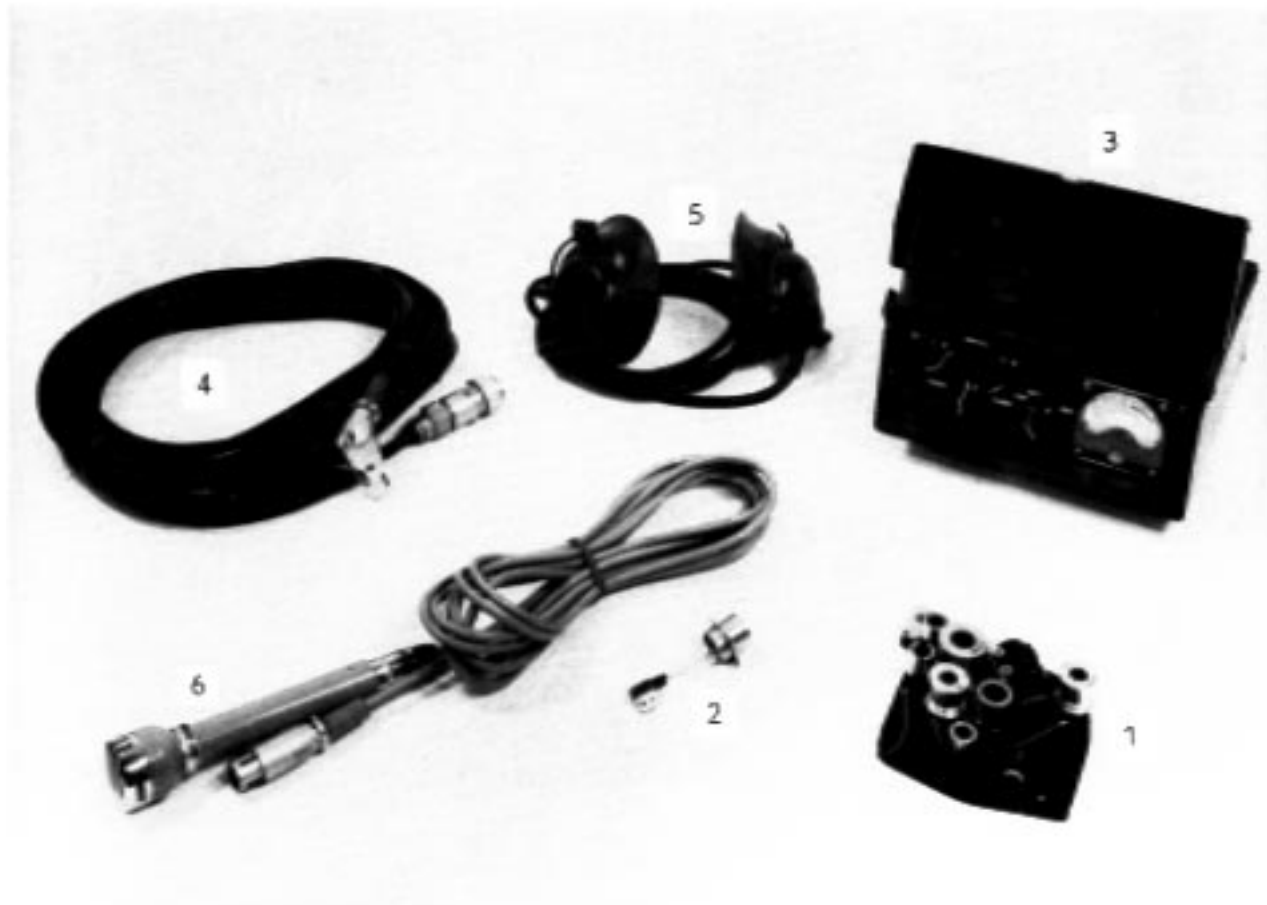

Figure 2

- 1 Complete magnetic single system unit incl. 3 mounting screws
- 2 Prepared sound connection incl. 6 mounting screws
- 3 Fully transistorized amplifier
- 4 Connecting cable from camera to amplifier
- 5 Earphones
- 6 Microphone
- 7 Shielded motor cap (not shown)

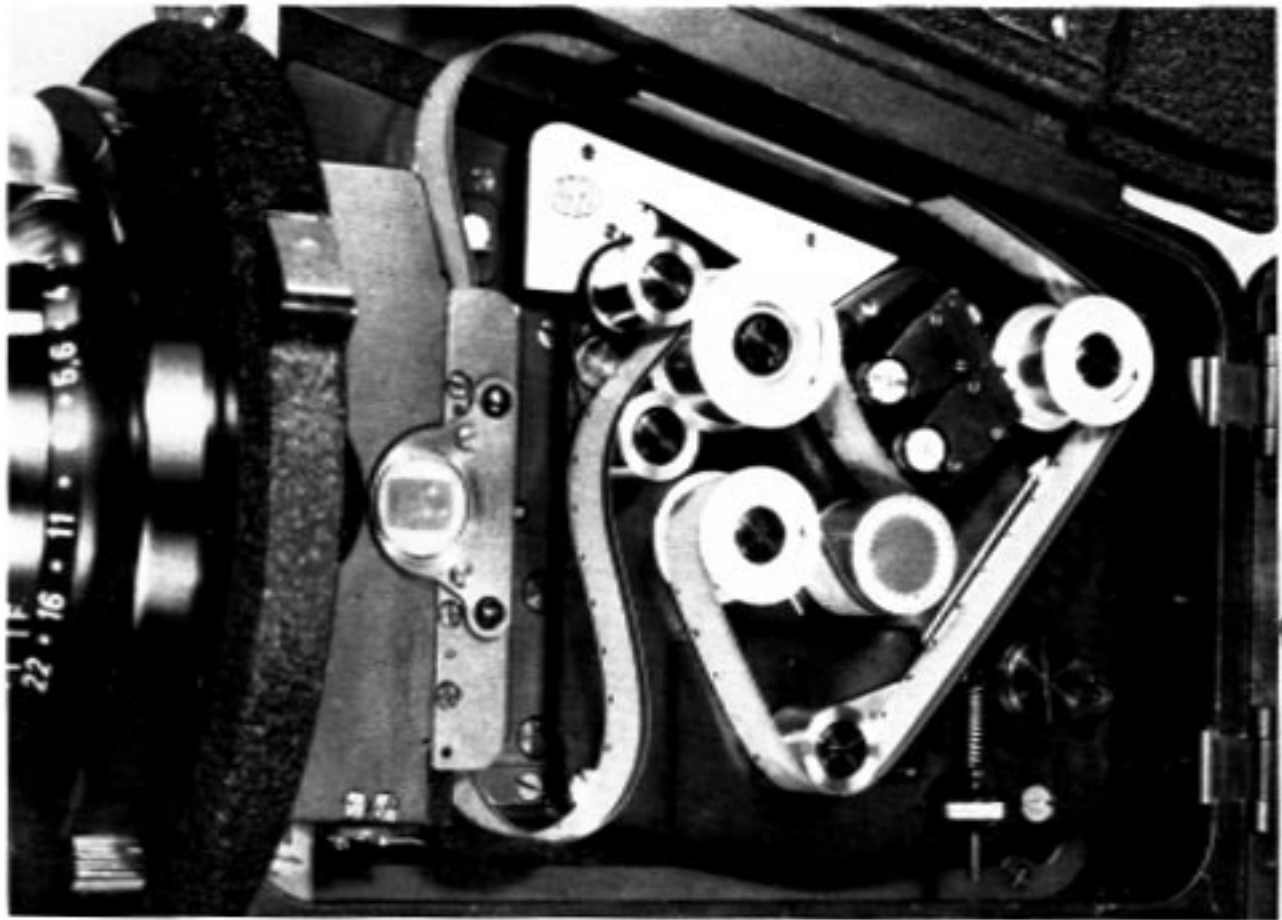

Figure 3

As can be seen in Fig. 3, the film path is laid out very clearly and marked on the plate of the magnetic single system unit. After leaving the magazine, the film passes through the film gate as usual; behind the gate it forms a large loop and passes on to a hold-back roller. From there it runs past the sound heads, loops round the flywheel-type sound drum and then passes round a guide roller which gives the film a sufficiently large loop angle relative to the sound drum. The film then passes over a tension roller and via a further guide roller back to the magazine mouth. The adjustable tension roller must be set for a pull strong enough to balance out the hold-back roller during film transport. The correct tension is set if, on switching on the camera, the tension roller swings right up to its stop and then returns immediately to its middle position. While the camera is running, the tension roller should not rest against its upper or lower stop. The threading of the magnetic sound drive unit is extremely easy, if the loop is the right length. As can be seen in Fig. 4, the magazine has a second marking for the longer loop to fit the sound unit. The magazine is mounted as usual, the only difference being the longer loop. When the loop has been threaded, 76 perforations must be visible outside the magazine mouth.

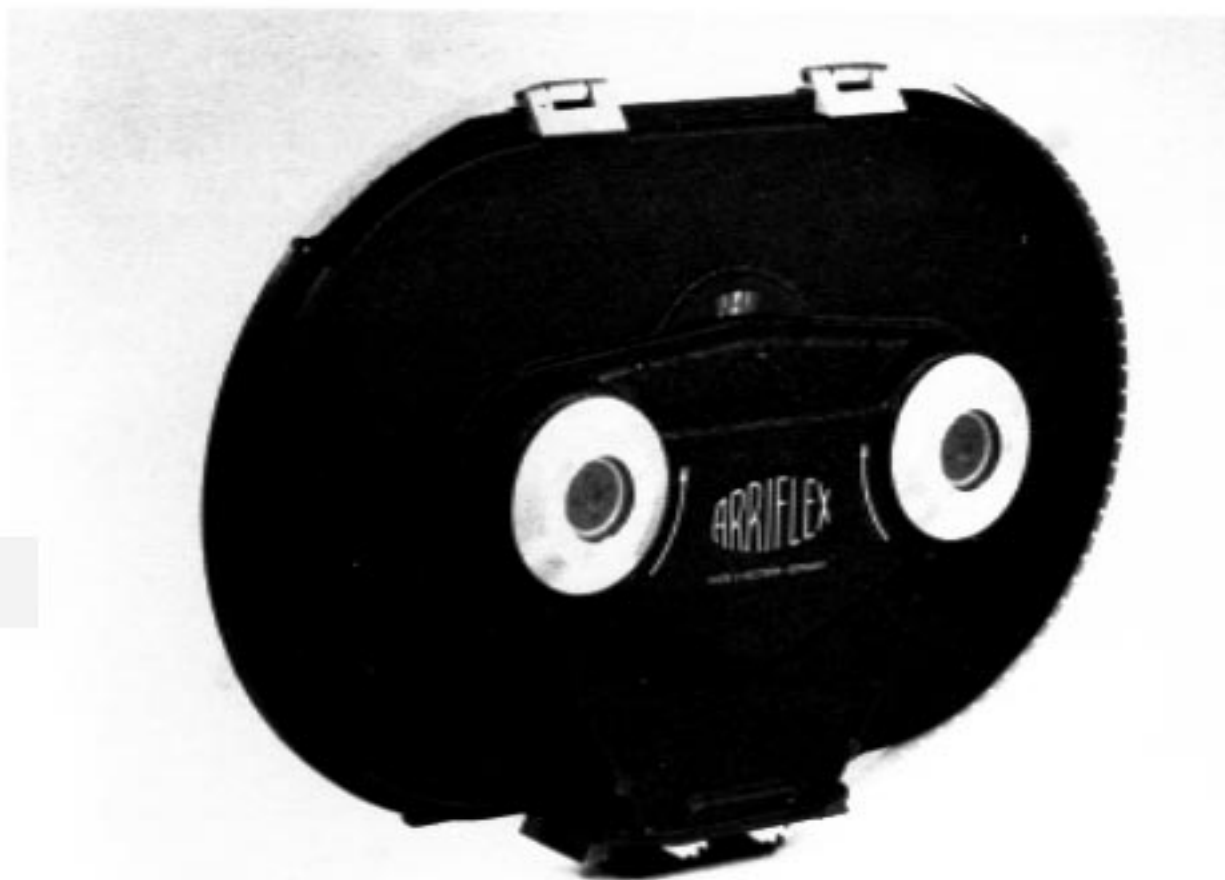

Figure 4

Film is threaded in the usual way, first forming the upper infeed loop, then passing the film through the gate and threading the remaining length of the loop as described above over the rollers shown in Fig. 3. When forming the loop behind the film gate, make sure that it is not too large, as otherwise it will rub against the bottom of the camera, and not too small or the standard distance of 28 frames between film gate and sound recording head will not be maintained. See the loop markings on the plate of sound unit.

The most sensitive parts of the sound unit are the heads. Tremendous care has been taken with the precise mounting and exact adjustment of the heads on the magnetic single system unit of the 16 BL camera. The setting of the heads should not be touched by the camera operator. It is common knowledge that the adjustment of magnetic heads is very critical, and this is done at the factory with maximum precision.

The most important consideration in mounting heads is the stability of the setting, which must remain perfect over the entire service life of the heads. When the heads are worn out, a new head assembly with new and exactly adjusted heads can be obtained and installed by the operator.

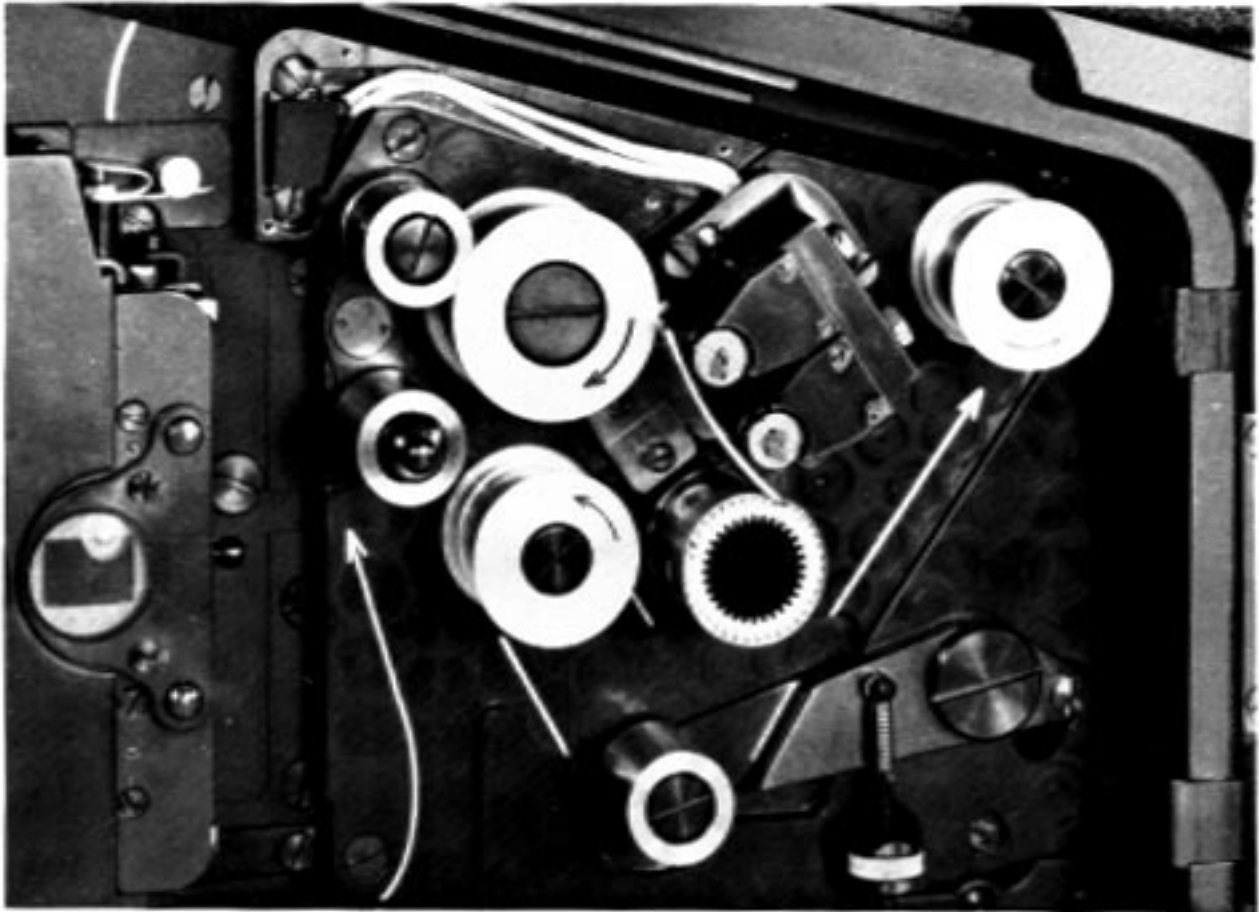

Figure 5

To exchange heads, remove only the three screws fastening the head support to the plate. In addition, the four countersunk screws holding the cover plate marked ARRI must also be removed. Beneath this cover plate lie the sound leads running from the head support to the connecting plug, see Fig. 5. Before lifting the head support off the positioning pins, the plug under the cover plate must be withdrawn by removing the two screws so that the head support can be taken out with the leads and attached plug. Reverse this procedure to install the new head support. In doing so, be very careful not to move any screws other than those mentioned.

Figure 6 shows how the camera is connected to the amplifier. The black cable with the 6-pole Cannon plug is the sound connection from the 16 BL camera to the amplifier, the grey cable is one of the two microphone connections.

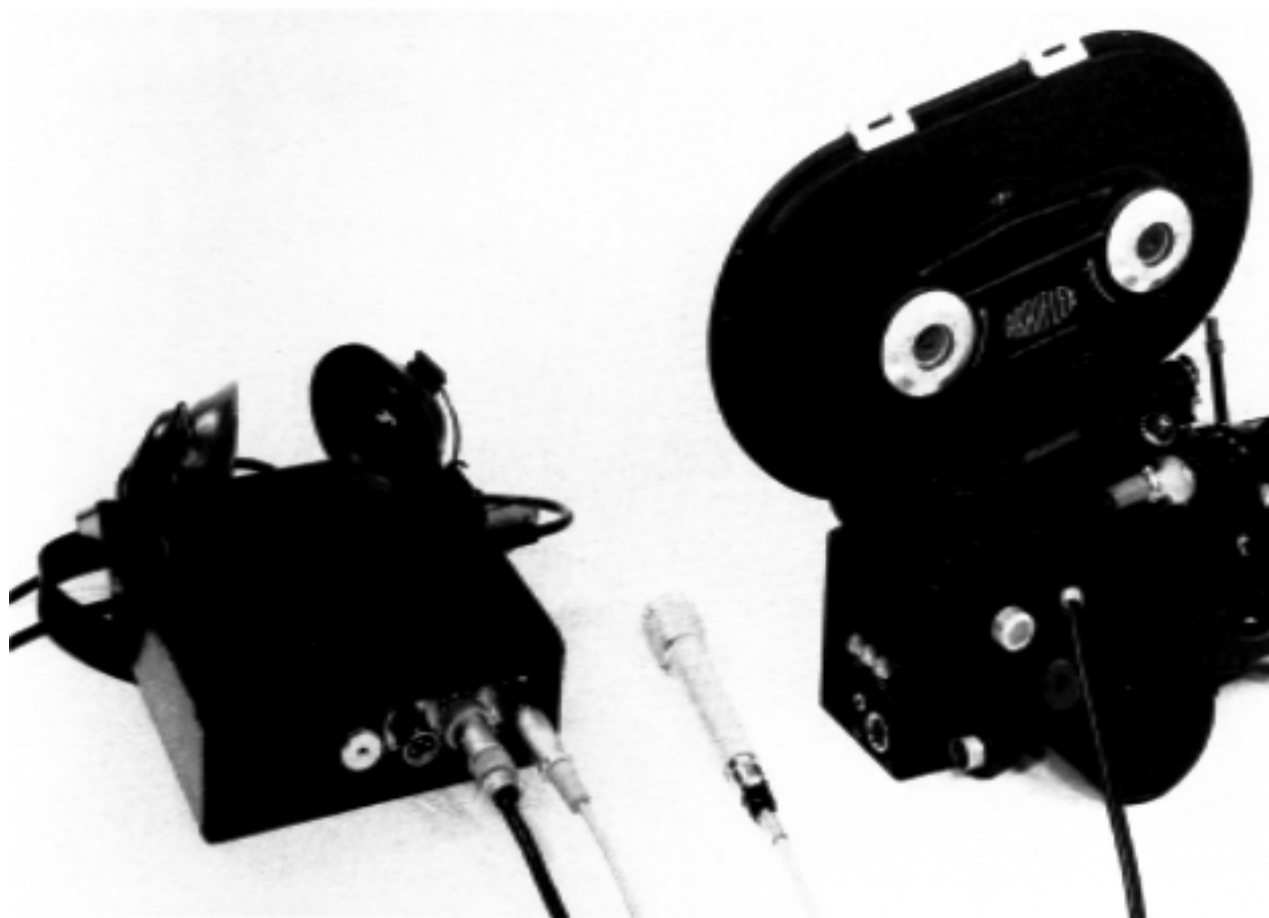

Figure 6

There is an earphone connection on both camera and amplifier. The camera earphone connection is the jack at the back next to the pilot tone connection (see Fig. 7).



Figure 7

The amplifier belonging to the magnetic sound unit contains an amplitude limiter that can be cut out if desired. One of the microphone inputs can be switched over to line level, that is, for available sound connections at public events, etc. The recording frequency response can be switched to C.C.I.R. or N.A.R.T.B. norms. An additional master output is provided for connection to a separate tape recorder.

The amplifier is delivered with detailed instructions for use.

The last picture on the next page shows the 16 BL camera with magnetic single system unit in operation as a single system picture/sound camera (see Fig. 8).



Figure 8

Fig. III

- 1 Inching knob
- 2 Zoom adjustment lever
- 3 Push button release
- 4 Zero re-set for metre (footage) counter
- 5 Toggle switch for forward a. reverse operation
- 6 Removable toggle switch cover
- 7 Metre (footage) indicator
- 8 Power plug connexion for camera motor
- 9 Connexion for pilot tone a. start marking system
- 10 Connexion for manual scene marking system
- 11 Connexion for earphones
- 12 Operation control lamp
- 13 Start marking system control lamp
- 14 Control lamp for manual scene marking system
- 15 Tachometer (f.p.s.)

Fig. IV

- 1 Transfer gear
- 2 Motor pinion
- 3 Mounting screws for motor
- 4 Start marking lamp for automatic full frame exposure (exchangeable)
- 5 Manual scene marking lamp (edge marking exchangeable)
- 6 Ground glass with etched format
- 7 Mounting screws for ground glass holder

Fig. V

- 1 Bellows frame
- 2 Lock for bellows
- 3 Filter door
- 4 Lens housing
- 5 One of the three locking lugs of the lens housing
- 6 Lens housing lock
- 7 Magazine mouth
- 8 Film channel
- 9 Filter holder
- 10 Plane glass or filter
- 11 Filter holder recess
- 12 Filter door lock
- 13 Locking lugs of lens
- 14 Slots in lens mount
- 15 Centering for lens housing
- 16 Push button to unlock lens
- 17 Mount for periscopic viewfinder
- 18 Periscopic viewfinder
- 19 Viewfinder adapter
- 20 Camera plug
- 21 Dryfit battery plug

Fig. III

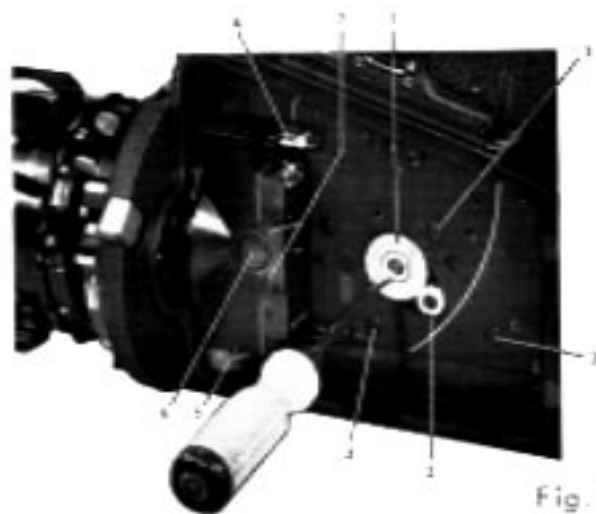
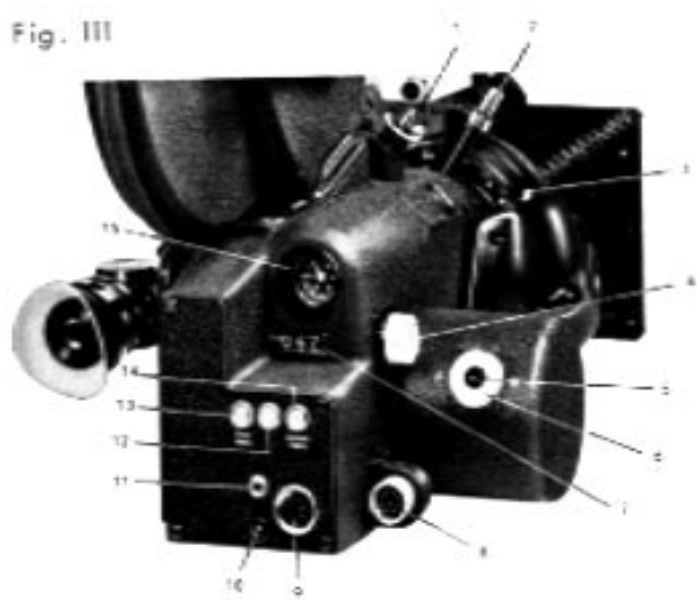

Fig. IV

Fig. V

