

# Braun Super8

**Nizo 6080**  
**Nizo 6056**

Instructions for Use

## The elements of your camera

- 1 Wind shield
- 2 Microphone
- 3 Knurled screw for the microphone bracket
- 4 Rocker button for the power zoom
- 5 Microphone bracket
- 6 Diopter setting on the eyepiece
- 7 Optional: eye padding or eyecup
- 8 Cartridge compartment lock
- 9 Two tripod threads on the camera base
- 10 Handgrip lock
- 11 Electrical master switch
- 12 Lock for the electrical master switch
- 13 Action signal
- 14 Cover for the accumulator chamber in the handgrip
- 15 Release button 1
- 16 Lock for transition to macro setting. UWL setting, de-activation of power zoom for manual zoom adjustment (only Nizo 6080)
- 17 Lens zoom ring
- 18 Focusing ring
- 19 + 1 button
- 20 Light-emitting diode (LED) for indication of fade-in/fade-out and cross-fade

- 21 Stop button for fade-in, fade-out, cross-fade and double exposure
- 22 Battery voltage test button
- 23 Footage indicator for 15 m and 60 m
- 24 Exposure switch
- 25 Trick switch
- 26 Filming speed switch
- 27 Automatic/manual sound recording level switch
- 28 Sound pause button
- 29 Release button 2
- 30 Recording level control
- 31 Single-frame switch and continuous mode switch
- 32 Shoulder support
- 33 Cartridge compartment cover for 60 m cartridge
- 34 Microphone mount
- 35 Cartridge compartment indicator
- 36 Switch for integrated filter
- 37 Individual adjustment of exposure meter
- 38 Microphone connection
- 39 «Sound off» microphone switch
- 40 Earphone or headphone connection
- 41 External power connection
- 42 Connection for Braun electromagnetic remote release

- 43 Sync connection for flash unit
- 44 Manual remote control
- 45 Hand loop

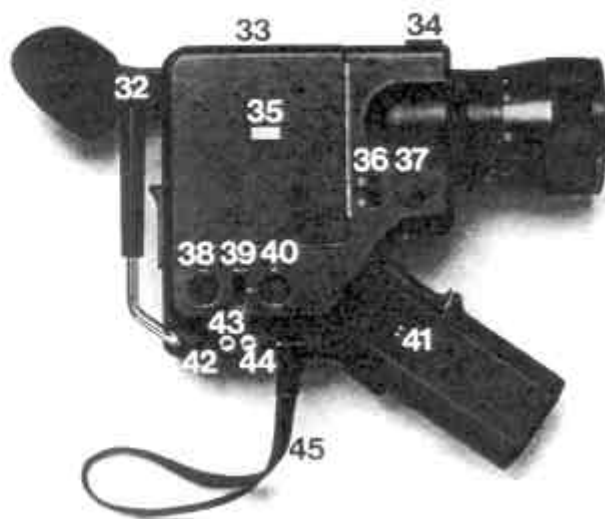

## The control centre in the viewfinder

Film transport check for silent and sound film cartridges with film end signal:  
Green lights up at intervals if the film is being transported properly. Green lights up continuously if the film has completely run through or is not (Only in the case of 15 m cartridge) being transported, during lap dissolve or as soon as the cartridge has been inserted.

Filter signal:  
This lights up red when the camera is switched on and the filter has been set to artificial light.

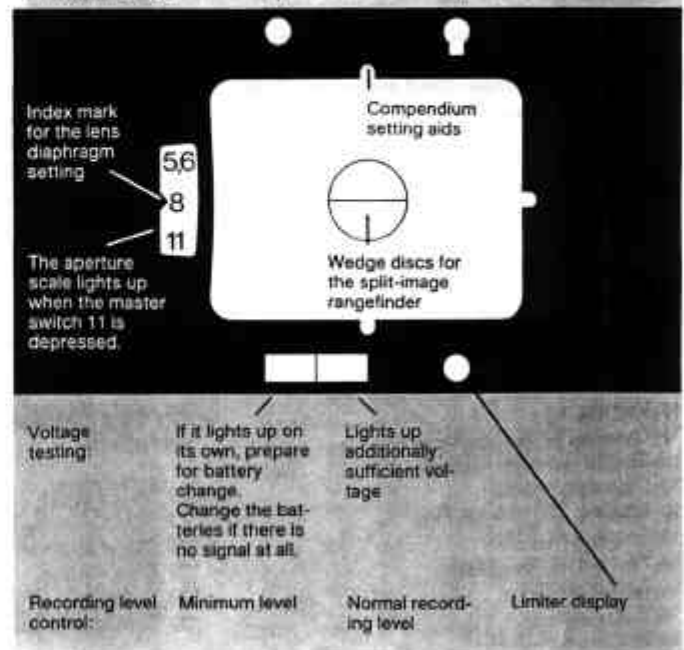

5

This manual is divided up into six sections.

**In the first section, you will find a summary of all the things you have to remember in order to shoot simple silent and sound films without tricks and effects.**

**The second section tells you what you have to know in order to operate your camera properly and shoot simple films:**

- 5 The control centre in the viewfinder
- 9 Handgrip
- 9 Shoulder support
- 9 Eyepiece
- 10 Sunshade
- 10 NC accumulator box and charging
- 11 Voltage test
- 11 Outside power connection
- 12 Electrical master switch
- 12 Cartridge loading
- 13 Loading a 60 m cartridge
- 13 Footage indicator
- 14 Film transport control
- 14 Action signal
- 14 Filter switch
- 15 Normal film speed

- 15 Fixed lens focus setting
- 15 Diopter setting on the eyepiece
- 16 Camera mount
- 16 Second trigger
- 16 Continuous mode switch
- 17 Remote release
- 17 Wire release connection
- 17 Tripod operation
- 18 Range metering
- 19 Exposure metering
- 19 Exposure metering with light contrasts
- 20 Lighting up shadows with backlight
- 20 Manual aperture setting
- 20 Individual exposure meter adjustment
- 21 Focal length setting
- 21 Manual focal length setting (only Nizo 6080)

**The third part explains filming with tricks and effects**

- 22 Macro shots
- 23 Shots with the UWL III
- 23 Super zoom shots
- 23 Slow motion
- 24 24 fps as a «shock absorber»
- 25 Simple time lapse

- 25 Time lapse effects with the automatic single frame mechanism
- 26 Switchover from 18 fps to time lapse
- 26 Manual single-frame switching
- 26 Single-frame shots with flash illumination
- 27 Trick switch
- 27 Programmed fade-out
- 27 Programmed fade-in
- 28 Programmed fade-in/fade-out
- 30 Combination possibilities of programmed fade-in/fade-out
- 31 Programmed lap dissolve
- 31 Reading the f/stop before programmed fade-ins/fade-outs and lap dissolve
- 33 Double exposures
- 33 Programmed double exposures with 15 m cartridges
- 34 Programmed double exposures with 60 m cartridges. Subsequently programmed double exposure with 60 m cartridges.

**The fourth section is about sound filming**

- 37 The microphone
- 38 The microphone on the camera
- 38 The microphone under the camera
- 39 The microphone on a stand
- 39 The microphone in your hand

6

- 40 The earphone
- 40 Automatic recording level control
- 41 Manual recording level control
- 41 Sound pause button
- 42 Fade-in and fade-out of sound
- 42 Switching off the sound
- 42 Sound dubbing at high levels
- 43 Technical data of the sound amplifier

**The fifth section tells you how to care for your camera**

- 44 Cleaning the front lens
- 44 Cleaning the film gate
- 44 Cleaning the sound capstan

**The sixth section tells you about accessories**

- 45 Supplementary lenses for extreme close-up shots
- 45 Super wide-angle lenses
- 46 Remote release
- 46 Remote-control microphone
- 46 Directional telescopic microphone
- 47 Directional tubular microphone

- 47 Adapter lead  
(Branch line for two microphones)
- 47 Dubbing lead
- 47 Compendium
- 49 Carrying case
- 49 The two-channel magnetic sound projector
- 49 Braun Visacoustic and sound recording

**The seventh section contains advice on what to do if something goes wrong.**

7

## Section 1: In brief

### Preparing the camera for use

Pull out cover 14 on the handgrip. Place the accumulator box with the contacts pointing towards the front. The small lug on the box should point upwards. Press button 22 to test the voltage. At least one green signal should light up below the viewfinder.

Press the slide 8 upwards. Carefully insert the silent or sound film cartridge in such a way that you can see the maker's label.

Fold down the shoulder support. Turn the black part of the support until it rests on your shoulder.

### Filming

All you have to do now is set the correct range by setting all the operating elements to the red dot markings.

(This places all the switches and controls in the correct position for normal film shots with automatic aperture setting).

You must measure the range precisely in order to adapt the viewfinder lens to the individual characteristics of your eyes. For range metering, always set to the extreme zoom focal length (56 or 80 mm).

The electrical master switch 11 is automatically released when you place your hand around the handgrip. After shooting, please make sure that you release the trigger first and then the electrical master switch.

A green signal lights up at intervals on the left above the viewfinder image when the film is being transported correctly.

A red signal on the right-hand side of the viewfinder image reminds you when the filter switch 36 is set to artificial light, for example, when you are taking indoor shots.

Before starting to film with tricks and effects, get to know the corresponding sections of the detailed operating instructions.

### Sound filming

Insert the plug of the microphone lead into the socket 38. Completely pull out the microphone.

Connect the earphone to the socket. You can monitor recordings through this earphone when slide switch 39 is set to «mic high» and when the master switch 11 is switched on.

Set the slide switch 27 to the red dot marking.

As a rule, it is best to leave the recording level control on the automatic system: for this purpose, turn switch 30 to its red dot marking. Look into the viewfinder to check the recording level: the normal recording level has been set if the complete green signal area lights up from time to time.

The recording level is too low if only the left-hand side of the green signal lights up from time to time.

Your recording-level is too high if the red signal occasionally lights up.

No sound is being recorded if no signal lights up at all.



## Section 2: Simple filming

Pull down the horizontal handgrip until it locks into position.

If you want to return the handgrip to horizontal position to return the camera to its carrying case or to place it on a wide tripod base, first of all press button 10.



The shoulder rest 32 provides the camera with an additional support besides your hand on the grip and your eye on the viewfinder.

When using your camera without a tripod, the shoulder rest helps to produce better, more stable pictures.

Fold down the shoulder rest. Place the camera to your eye and turn the black part of the rest until it touches your shoulder.

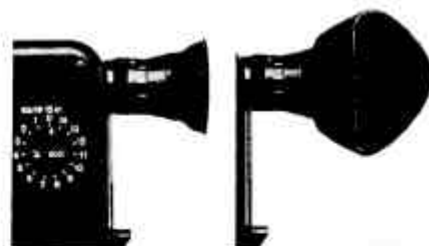

The correct distance between your eye and the viewfinder is established by the eyecup and the eye pad.

The eye pad is particularly useful for spectacle wearers as the spectacles sit flatter on the eyepiece.

The eyecup is provided to protect the eye against disturbing sidelight and can be placed over the edge of the eyepiece instead of the eye pad.



You can check the battery voltage by pressing button 22 marked "batt.", look through the eyepiece at the same time. At least the left-hand side of the divided green signal must light up in the bottom edge of the viewfinder frame. Do not forget to press the master switch 11 at the same time.



The Braun accumulator box can stay in the camera handgrip while it is being recharged or, if you so wish, can be removed for this purpose.

The included charger (Braun SR 9) must be set to the correct mains voltage. You can select the voltages 100 to 120 or 200 to 240 V by turning a coin in the groove on the bottom of the charger.

Insert the plug of the 50 cm long charger lead into the socket of the NC accumulator box. Connect the charger to the mains with the 150 cm mains lead.

The red LED in the cover of the charger lights up when it is charging up properly.

The NC accumulator box is fully charged after nine hours.

Afterwards, the charger automatically stops charging in order to prevent overloading, the red LED is then extinguished. Charging begins again if the connection between the mains and charger or between the charger

and NC accumulator box is interrupted and re-connected. Therefore, avoid switching off the charger during charging as otherwise there is a risk that the accumulator box will be overloaded.

However, the Braun NC accumulator box can be left connected to the mains for an unlimited period and the natural self-charging process of the sintered cells is constantly balanced out by a maintenance charge.

The accumulator box must be recharged every eight weeks if possible or should not remain connected to the mains. Otherwise the accumulator will lose its efficiency.

Charging outside the camera is particularly useful if you happen to have a second accumulator box (optional accessory).

Do not open your charger if it is defective, send it to a Braun servicing agent.



Alternatively, you can leave the Braun NC accumulator box in the camera's handgrip whilst it is being charged up. In this case, insert the plug of the charging lead in the outside power socket 41 of the camera.

The camera's electrical master switch 11 must not be locked in -on- position.

If your Nizo camera is left unused for some time, it is recommended to charge up the NC accumulator box before storing the camera and to recharge it every three weeks. Alternatively, you can remove the box from the handgrip and store it separately; the box can be stored for two months at normal room temperature without being.

Please note that the charger must not be connected if no accumulator box has been inserted.



The electrical master switch 11 activates the power supply when you hold the handgrip during filming.

You can lock the electrical master switch 11 in operating position (depressed) and in rest position with slide 12.

For this purpose, the slide is shifted in the direction of the master switch.

The master switch 11 must be locked in operating position in order to operate the camera with the second release button 29 or by means of a wire release or remote release.

**Important:** A standby current flows as long as the master switch is locked in the standby position by the slide. This can drain the accumulators, even if no filming is done with the camera. Therefore, before putting down the camera or placing it back in its case, make sure that the master switch is not locked in operating position. Instead, lock the master switch in the rest position.



You can use all Super-8 silent or sound film cartridges in your camera. When the camera is loaded, the automatic exposure control is set to the speed of the film used within the following ranges:

Camera filter switched off (using artificial light): 17 to 29 DIN = 40 to 640 ASA

With camera filter (using daylight): 15 to 27 DIN = 25 to 400 ASA

Open the cartridge compartment of the camera to insert the film cartridge. For this purpose, shift the knurled sliding lock 8 upwards. When inserting the film cartridge, make sure you can see the maker's label. Insert the cartridge in the film channel at a slight angle and, at the same time, carefully press down on the left-hand side of the cartridge until it sits in the camera.



You must secure the microphone mount 5 and the microphone 2, shifted by an angle of 90°, on the camera before inserting a 60 m film cartridge.

Loosen the knurled screw 3 on the microphone mount 5 on the camera.

Turn the mount along with the microphone.

At right angles to the camera, screw the mount with the microphone into the thread of the microphone holder 34 on the top of the camera.

Open the camera's cartridge compartment. For this purpose, push up the knurled slide 8. Flip the cartridge compartment cover upwards for the 60 m cartridge 33.

Insert the film cartridge so that you can see the manufacturer's label. As in the case of the 15 m cartridge, insert the cartridge in the film channel at a slight angle and then smoothly depress the left-hand edge of the cartridge into the camera. (Refer to the figure on Page 12). Never insert the cartridge from above.

Please remember that the cover of the cartridge compartment for the 60 m cartridge 33 can only be closed if the cartridge compartment itself is opened.

With a 60 m cartridge inserted, hold the camera as shown in the illustration.

Please do not touch the part of the 60 m cartridge which sticks out. Do not touch this even when transporting and supporting the camera.

**Note:**  
For normal circumstances, i. e. camera with 15 m cartridge and microphone, a larger microphone fastening screw is included in the scope of delivery.

If you frequently use 60 m cartridges in conjunction with the Braun compendium (accessories), you can also leave its mounting rail on the camera and fasten the microphone onto this rail with a large screw.

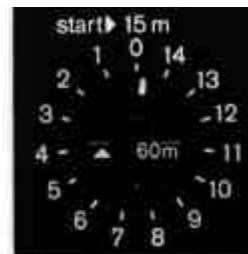

You can read off the available film footage in meters by means of the footage indicator 23.

Fifteen millimeter cartridges are indicated on the outer scale.

The inner segment is for 60 m cartridges.

Sixty meter cartridges are indicated by four times 15 m and the red segment in addition.

Please note that the footage indicator jumps back to its initial setting when the film cartridge is removed.

This is especially important if you remove a cartridge from the camera which is not quite completely exposed, for example, to do some shooting with a more lightsensitive material.



Whilst you are shooting your films, the green flashing illuminated signal on the left above the viewfinder image informs you that the film is being transported properly.

The signal lights up continuously (only in the case of 15 m cartridges) if the film has come to an end (but also in the case of overexposure or double exposures). Then push the slide 8 upwards: the flap of the cartridge compartment then opens.

If you push the slide up further, the cartridge is raised slightly and can be removed easily from the camera.

If the word «exposed» appears on the film in the cartridge opening, the film has come to a complete end.



The actors in front of the camera (for example, during a sound film interview) are clearly informed when shooting begins and ends by the action light 13. This flashes in the same rhythm as the film transport control light in the viewfinder.

Once the film has come to an end, if the camera is running without a film or in the case of lap dissolve (or double exposure only in the case of 15 m cartridges), the signal lights up continuously.



Super-8 film cartridges contain colour films which can be used for daylight filming and filming in artificial light if the camera's integrated conversion filter is set accordingly.

For daylight scenes, turn the filter 36 to the sun symbol. In order to film with artificial lighting, turn the filter switch 36 to the lamp symbol.

When the camera is set to artificial light, a red lamp symbol appears on the right-hand side above the picture in the viewfinder to remind you that you have selected this filter setting. The master switch 11 must however be depressed.

After shooting with artificial light, do not forget to turn the filter switch back to daylight as otherwise the film material will be ruined by a bluish tint. Set the filter switch to the lamp symbol when using black/white films.

14

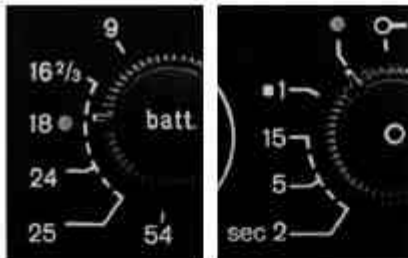

You can select the filming speed with the filming speed switch 26 or the single frame switch 31.

At the beginning, set both switches to the red dot markings.

You will then be filming at the normal film speed of 18 frames per second.



You can also shoot films without exact range metering by adjusting the camera to its «snapshot setting» or red dot setting.

The numbers 4 (meters range) and 15 (mm focal length) are marked red on the focusing ring 18 of the lens and the zoom ring 17, respectively. Set both of these to the white marking.

With this setting, you can film with a depth of focus from 1.79 m to  $\infty$ , even if the light is relatively weak (aperture 4). The depth of focus can be improved if the light is better and the zoom ring is set to a lower number.



Before range finding, make sure that the optical system is adapted to the individual characteristics of your eye.

The eyepiece can be adjusted between approximately  $-8$  and  $+5$  diopters. However, the individual marking lines on the eyepiece ring 6 do not correspond exactly to the individual diopter values.

Set the focusing ring to infinity and the zoom ring to the longest focal length.

Point the camera towards an object with a preferably vertical character (e. g. a tree, chimney, telegraph pole) which is at least 100 m away.

Now turn the knurled ring of the eyepiece 6 until the object no longer appears divided in the centre circle of the wedge disc. This completes basic setting of the viewfinder.



The photograph shows you the best way to hold and operate the camera during filming.

It does not matter whether you hold the handgrip with your left or right hand; in any case, you can easily operate the release button 15 during filming.



Your camera has a second release too, which you can use when the handgrip is folded horizontally.

Press the master switch 11.

Lock it in operating position with the slide 12.

Then press the pushbutton switch 29.



You can also switch the camera to continuous running.

Press the master switch 11. Lock it in operating position with the slide 12. Turn switch 31 to the circle marking.

The camera runs until switch 31 is returned to the red dot marking.

Then switch off the master switch by unlocking it.

16



You can also start and stop the camera drive mechanisms with a remote release.

You can also shoot single frames with the remote release.

The remote release is described in section 6 under «accessories».

Insert the plug of the remote release cable in socket 42.

Press the master switch 11. Lock it in operating position with the slide 12.



You can use a wire manual release to manually shoot single frames or, to start and stop the camera with the swivelling lever of the tripod.

Screw the wire release into the thread 44.

Press the master switch 11. Lock it in operating position with the slide 12.



Shooting scenes with a tripod is always recommended because

- the pictures appear steadier on the projection screen
- movement of the camera is smoother
- trick shots with the single-frame mechanism and time lapse shots with the automatic single-frame mechanism are impossible without a tripod.

Two threads 9 can be found on the base of the camera. The tripod screw is bound to fit into one of these two threads.

You can fold away the handgrip horizontally if it gets in the way. In this case, you can control the camera with button 29, or with a wire or remote release.





For exact range finding, follow the instructions below:

First of all set the longest focal length with the zoom ring.



Look through the viewfinder and sight your object.

In the split-image range finder you can see that the vertical lines of the subject are displaced to one side as they cross the horizontal line of the range finder.



Now turn the focusing ring until the vertical lines of the subject meet with the horizontal line of the range finder. Once you have done this, you have correctly adjusted the range finder.

If you now change the focal length by turning the zoom ring 17 or by depressing the automatic power zoom button 4, you can take -zoom shots- without fearing that the shorter depths of focus of the zoom focal lengths will blur your shots.

18



The exposure is automatically measured through the lens when the rotary switch 24 is set to the red dot marking.

At the same time, the following are taken into consideration:

- the focal length setting
- the lens combination of the Vario lens
- the setting of the integrated filter
- the different filming speeds
- viewfinder light reflection

Therefore, it is not possible to compare results of this system with the results obtained from a manual exposure meter.

The energy required to control the lens diaphragm comes from the accumulator box.

The automatic exposure system operates as soon as the electrical master switch 11 is set to operating position. However, measurements can only be carried out with a film cartridge in position.

Set the aperture switch 24 to the red dot marking. Look into the viewfinder. The aperture scale moves past the index mark and stops at the measured results.

If it is too bright, there will be a red area opposite the index mark (overexposure). You can continue filming with the Nizo grey filter (refer to section 6: accessories). If it is too dark, a red-green area can be seen opposite the index mark (underexposure). This signals that you can still successfully continue filming with many objects.



In the case of extreme light contrasts in the object, set the focal length on ring 17 in such a way that you can only see in the viewfinder what you actually want to film.

The resulting aperture setting is permanently set if you turn the aperture switch 24 to the -fix- marking. The aperture scale in the viewfinder now no longer moves if you once again have the light contrast in your viewfinder with a shorter focal length.



If you find that the shaded areas of the object are more important than the lights, you can continue working with the automatic exposure system with the aperture increased by «+1» setting.

In the case of backlight, this is most frequently the case when the objects are not to appear as silhouettes. For this purpose, depress button 19 with «+1» marking and hold the button depressed until you have finished shooting your scene.

For longer scenes, you can set the aperture switch 24 to the «+1» marking.



You can utilize the smooth focal length transitions of your camera's zoom length for picture composition purposes by concentrating on the essential or for «zoom shots».

For picture composition before shooting, you can set the desired focal length and also the angle of view by turning the zoom ring 17.

You will avoid exhausting the accumulators if you do not use the power zoom.

Depress the front part of the rocker button 4 for «zoom shots» to the wide angle setting. For the telesetting, depress the rear part of the rocker button. The button has a mark which you can feel, this is to remind you that this setting is critical because the depth of focus is now narrowed down. The range must therefore be set carefully beforehand.

The rocker button 4 controls the speed of the power zoom in two steps: the power zoom operates slowly when the button is only half depressed and quickly when the button is completely depressed.

The effects of a «zoom shot» can be made smoother by setting the speed to 24 fps.

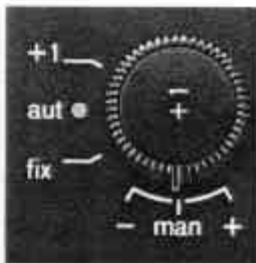

If you then wish to set a certain aperture, turn the aperture switch 24 to the «man» marking.

You can now set higher (lower numbers on the aperture scale in the viewfinder) or lower (higher numbers) apertures by turning the spring-mounted switch upwards to the plus (+) marking or forward to the minus (-) marking.

Release the switch when the desired aperture appears in the viewfinder next to the index mark of the aperture display.

Important: When filming shots with aperture correction, return the aperture switch 24 to the «aut.» setting after you have finished filming.



The automatic exposure system of your Nizo camera is precisely adjusted at the factory.

However, you can alter this adjustment in accordance with your personal wishes. If you would like to have more pastel, smoother shades and brighter larger projection, turn the individual adjustment switch 37 to the left (+) to its first click-stop position.

The automatic exposure system now continues on the basis of approximately one plus one third aperture. The next two click-stop positions offer approximately one third aperture more.

If you would like to have stronger, denser shades, turn switch 37 to the right (-). Each click-stop position corresponds to approximately one third of an f/value (= 1 DIN).



With the Nizo 6080, you can deactivate the motordriven automatic zoom system and can smoothly control the focal length manually. You literally have the speed in your hands and can cover the entire focal length by quickly shifting the lever for dramatic effects.

For this purpose, you must screw the hand-lever into the thread on the zoom ring 17 and you must set the white marking of the knurled ring 16 to the white mark «0».

Once you have got this far with studying the operating instructions, you can begin filming to try out all the things you have learned so far.

If you would also like to record sound on your first films, please read section 4 of the instructions.



### Section 3: Filming at all levels

With the macro setting you can film all objects that come closer than 1.5 m to the lens.

However, please remember that for macro shots the angle remains always at a focal length of 7 mm.

With the full setting, you can achieve an object field size of 24 x 32 mm (Nizo 6056) or 33 x 44 mm (Nizo 6080).

One alternative is to use close-up lenses (refer to accessories).

In the case of macro shots with the zoom control, the range is either set with the rocker button 4 or, even better, manually with the zoom ring 17.



When filming with the power zoom, turn the knurled ring with the white mark to the red marking «macro». Sight the object. Then precisely focus the camera with the rocker button 4 for the power zoom.

For manual setting, turn the knurled ring 16 with the white marking to the white marking «macro». Sight the object. Precisely focus the camera. For this purpose, turn the zoom ring 17 until the split-image range finder is exactly set to the object.

The normal range setting on the focusing ring 18 is of no significance while you are filming in the macro range. Focusing in the macro range takes place millimeter by millimeter and only as long as the focal length indication stays in the area marked «macro».



With the macro setting, you can take «zoom shots» starting off from the macro range. Please make sure that the range is exactly set with the focusing ring.

For example a zoom shot from a mountain flower in close-up to a distant cross on the top of a mountain at infinity.

In order to do this, observe the following instructions: first of all sight the further distant object (in this case, the cross on top of the mountain) and, with the maximum focal length (80 mm or 56 mm) precisely set the range with the focusing ring of the lens (which in this case will lead to the infinity setting).

22



Leave the focusing ring set in this way.

Sight the object in the macro range (in this case, the flower).

Then focus the camera exactly. For this purpose, either use the button of the power zoom or the zoom ring. Start the camera drive and, during filming, move through the complete macro range with the button of the power zoom and — without stopping — then through the complete zoom range.

For filming with the ultra-wide lens, set the focusing ring to infinity ( $\infty$ ) and set the knurled ring 16 to the «UWL» marking with the white mark. Now, proceeding from the maximum zoom setting (56 mm or 80 mm) turn the zoom ring in the direction of «macro» until it moves no further (manually or with the motor), thus achieving the exact UWL position. With this setting, and with the lens fully open, you have a depth of focus range from infinity ( $\infty$ ) to approximately 0.35 m.



Up to now, you have been using a filming speed of 18 frames per second (fps). In this case, each individual frame of the film is exposed for 1/32 seconds.

If you run the camera faster during shooting, and afterwards set the projector to 18 fps, the filmed sequence will be distributed over a longer projection period. Your film shots will then be «stretched out». All filming speeds of more than 18 fps are referred to as time-lapse speeds.

You can obtain a three-fold time-lapse effect with the 54 fps filming speed of your Nizo camera. This means that one filmed second will become three seconds on the projection screen. When this is called «slow motion», we mean that it is possible to see more on the screen than with the naked eye.

If you want to shoot scenes in slow motion, set the filming speed switch 12 to 54 before filming. Please remember that each individual frame will now be exposed for 1/96 seconds. To compensate for this, the lens diaphragm automatically opens up by approximately 1 1/2 f-values.



However, a larger aperture shortens the depth of focus.

For this reason, the range must be carefully measured and set beforehand.

A filming speed of 54 fps requires more energy than the slower speeds. If the drive energy starts to fade, carry out a voltage test as described on page 11.

Of course, the time-lapse shots are also possible with sound film cartridges. However, in this case, sound recordings, fade-ins, fade-outs, cross-fades and the first phase of double exposures are not possible.

A slight time-lapse effect is obtained with 24 fps. In this case, each frame is exposed for 1/43 s. However, this is sufficient to make all kinds of camera motions appear more elegant on the projection screen.

For example, choose the 24 fps speed if you are not able to hold the camera steady perhaps when filming from a moving car. This running speed will then have a «shock absorbing» effect on your filmed scenes.

Twenty-five fps comply with the requirements for electronic scanning of your film images for the purposes of playback by a European television broadcasting station. You can also use this filming speed in the same way as 24 fps.

Sixteen and two-thirds fps comply with the requirements for scanning of your film by a corresponding playback circuitry for playback via a television set.

While the camera is running, filming speeds must be switched over swiftly from one click-stop position to the other.

It is basically always possible to change the filming speeds whilst the camera is running. However, exposure fluctuations may occur as the exposure system has to adapt itself to the different filming speed. If you wish to avoid this, always set the desired filming speed before starting the camera.



If you would like to run the camera more slowly during filming and then run the projector at 18 fps, your complete filmed sequences will be longer than the normal projecting time.

Scenes filmed in such a way are called time lapse. Simple time lapse is possible if you set your Nizo to a filming speed of 9 fps. When projected, natural sequences of motion will then appear to be twice as fast. In this case, each single frame will be exposed for 1/16 th of a second. To compensate for this, the lens diaphragm will close by one f/stop more (e.g. from 5.6 to 8). This may be advantageous if lighting conditions are poor as, in this case, the display of the automatic exposure mechanism will move out of the red-green area and you will be able to continue filming. Sound film can be shot at 9 fps, but this is not suitable for normal playback.

The next section contains information on time-lapse techniques with your camera.



The automatic single-frame system permits effective time-lapse shots. However, you must have a very solid tripod. The best idea is to screw your camera onto a three legged tripod and to set switch 26 to 18 or 16 2/3. Set switch 31 to 15 s. A frame will then be exposed approximately every 15 s. This corresponds to a 270-fold time-lapse. Five seconds: A frame is exposed every 5 s. This corresponds to a 90-fold time-lapse. Two seconds: A frame is exposed every two seconds. This corresponds to a 36-fold time-lapse.

The individual frames of the film are exposed with an exposure time of 1/32 s when switch 26 is set to 18. An exposure time of 1/29 s is achieved when switch 26 is set to 16 2/3. Filming begins as soon as the master switch 11 is depressed. Lock it in position with the slide catch 12.

The audio amplifier is automatically switched off during filming with the single-frame mechanism. However, it is also possible to shoot time-lapse scenes using a sound cartridge.



You can switch from the normal 18 fps filming speed or from 16 2/3 fps to single-frame operation, very easily.

Set the desired time-lapse speed as described.

Depress the electrical master switch 11. Lock it in position with the slide catch 12.

Depress button 29 or the release button 15. The fixed time-lapse speed will continue when you release either of these.



You can also shoot single frames manually with a wire release or with the Nizo remote release. You then have the filming speed and time-lapse effect at your control.

However, manual filming of single frames is primarily recommended for animation tricks, or if you want to animate puppets.

Screw the wire release into the threaded mount 44 or plug the Nizo remote release into socket 42.

Set switch 29 to «■ 1» and the filming speed switch 26 to the red dot marking. Depress the master switch 11. Lock it into operating position with the slide catch 12. The shortest single-frame switching cycle is 1/2 s and the audio amplifier is automatically switched off.



Time-lapse shots of heat-sensitive objects (e.g. plants or documents) is only possible by using electronic flashlight for illumination. This is heat-free, similar to daylight and has a constant colour.

The energy-saving thyristor circuitry of the Braun 2000 VarioComputer flash guns is ideal.

The flash recycling time must be considerably less than the switching cycle of the camera. Please remember that the flash unit requires energy, immediately it is switched on.

In certain circumstances, it is necessary to operate the flash unit from the mains during shots of long duration. This is possible with some Braun 2000 flash units, with a corresponding mains flash lead.



Insert the plug of the flash sync. into socket 43 of the camera.

Set the filter switch 36 to daylight (sun symbol).

Determine the lens aperture with the computing dial at the flash unit in the same way as you would to prepare for a normal photographic shot. The required f/stop must be corrected by +1 value (therefore, for example, set f/stop 5.6 instead of 8). Lock in this aperture setting with switch 24, as described on page 19.

Set switch 31 to 15 s or 5 s. One single frame will then be exposed and transported every 15 or every 5 s.

You can also manually switch single frames (by means of the wire release or remote release) and trigger off the flash unit by setting the switch to «■ 1».



Your Nizo camera provides you with many different possibilities for elegant scene changes and astounding film tricks. Below is a summary of the features on your camera. All these functions can be used with filming speeds 9, 16, 18, 24 and 25 fps.

Symbol	Significance
	«Quick» fade-in and fade-out (approximately 2 s)
	«Smooth» fade-in and fade-out (approximately 4 s)
	«Quick» cross-fade (approximately 2 s)
	«Smooth» cross-fade (approximately 4 s)
	Double exposure
R 60 m	Not preprogrammed double/multiple exposure (only possible with 60 m cartridges!)

The light-emitting diode (LED) indicates when the first phase of a fade-in, fade-out or cross-fade has been carried out and stored. The LED is not extinguished until the second phase of the fade-in, fade-out, or cross-fade has been initiated.

A programmed fade-in will not take place if you replace the accumulator between a programmed fade-out and fade-in.

Button 21 «start» serves to start the first phase of fade-in, fade-out, cross-fade, double exposure and double and multiple exposures.

This button also serves to start the second phase of fade-ins, fade-outs, and cross-fadings.

The camera automatically transports the film backwards after the first phase of fade-in and programmed double exposure with 15 m and 60 m cartridges. There is a delay before the rewind of 3 seconds after the first phase of crossfading or double exposure.

This delay is necessary to ensure that the aperture is closed before the film is re-wound.

The master switch 11 must be kept switched on until the film is completely transported back.



Fade-ins and fade-outs are important filming signals which clearly show that one topic has finished and that a new topic will appear on the screen.

Before shooting a scene which you would like to complete with a fade-out, set switch 25 to the required fade-out «**▶▶**» or «**▶▶◀◀**». Then start filming.

At the end of a scene which you would like to finish with a fade-out, carefully and briefly depress button 21.

Keep an eye on the aperture scale in the viewfinder. You can then check that the aperture is completely closed when the red area runs past the index mark. The camera motor stops automatically when the camera has completed fading-out.

If the lighting conditions are extremely poor (e. g. working aperture 1.4), the aperture closes to a value of 8–11, thus completing the fade-out.

Note: the camera is now programmed to automatically begin the next scene with an automatic fade-in.



You must cut out the programming by turning switch 31 from the «red dot» marking to «**■ 1**» and then back to the «red dot». LED 20 will then be extinguished.

Sound fading-in and fading-out is coupled to the fading-in and fading-out of film scenes. This takes place without switching noises.



Before shooting a scene which you would like to begin with a fade-in, set switch 25 to the desired type of fade-in «**◀◀**» or «**◀◀▶▶**». With the master switch 11 switched on, depress button 21. LED 20 will then light up. Look into the viewfinder. Wait until the red area of the aperture scale is next to the index mark. Then carefully and briefly depress button 21 at the same time as you depress the release button 15. The following scene will then begin with the programmed fade-in.

Please remember that the camera will not run if button 21 is not depressed!

LED 20 will remind you of this. The LED does not go off until you begin the programmed fade-in by actuating the release button 15 and button 21.

Sound fade-in and fade-out is synchronously coupled to the fading-in and fading-out of film scenes. This takes place without switching noises.

28



For pre-programmed and automatic fading-in and fading-out of the following scene, set switch 25 to the desired fade-in and fade-out «**▶▶**» or «**▶▶◀◀**» and start filming.

At the end of the scene which you would like to complete with a fade-out, carefully and briefly depress button 21.

Keep an eye on the aperture scale in the viewfinder. You can then check that the aperture is completely closed when the red area runs next to the index mark. The camera motor will automatically stop when the camera has completed the fade-out. The camera is now programmed to automatically begin the next scene with an automatic fade-in. For this purpose, depress the release 15 and, at the same time, carefully and briefly depress button 21.

Please remember that the camera will not run if button 21 is not depressed!

LED 20 will remind you of this. This will light up after you have depressed button 21 to initiate a fade-out with a subsequent, pro-

grammed fade-in. The LED will not go off until you depress button 21 the second time (for fade-in).



The fade-in programming will not take place if you replace the accumulator between programmed fading-in and fading-out operation. LED 20 will be extinguished.

You can then reprogramme the camera. Set switch 25 to the desired fade-in «**▶▶**» or «**▶▶◀◀**». With the master switch 11 switched on, depress button 21. LED 20 will light up. Look into the viewfinder. Wait until the red area of the aperture scale is next to the index mark.

The camera is now once again programmed for fade-in.

Sound fade-in and fade-out is synchronously coupled to picture fading-in and fading-out. This takes place without switching noises.

Cross-fading «lap dissolve» is best achieved by setting the filming switch 26 to 18 fps. Good lap dissolves at 24 fps or 25 fps are achieved at aperture settings between 2.8 and 11.

For automatic lap dissolve, set switch 25 to the desired cross-fading mode -  - or  -.

Depress button 21 at the end of a scene.

Do not turn switch 25 as long as automatic fade-out is running.

After an automatic fade-out and a pause of approximately 3 s, the film is automatically transported backwards for approximately 2 or 4 s. The camera then stops automatically.

Please note that the camera automatically transports the film backwards after the first phase of cross-fading. This takes place 3 seconds after the first phase of cross-fading or double exposure.

This delay is necessary to ensure that the aperture is closed before the film is re-wound.

The master switch 11 *must* be switched on until the film has been completely re-wound.

At this time, the action signal on the camera and the pilot light to indicate film transport in the viewfinder, do not flash (except in the case of 15 m cartridges).





The camera is now programmed for the second part of the lap dissolve. This consists of fading-in to the same piece of film on which the fade-out took place.

To do this, actuate master switch 11, press the release 15 and then press button 21. Only then will the camera start to run.

LED reminds you that a lap dissolve is being carried out. It lights up after you have pressed button 21 for the first part of the cross-fade (fade-out and film re-wind). LED 20 is not extinguished until you press button 21 for the second time in order to initiate the fade-in phase.

If possible, please try to avoid changing the accumulator between the first and second phases of lap dissolve, as otherwise the automatic programming will be cut out.

You can however reprogramme the camera. Set switch 25 to the desired lap dissolve mode -  - or  -. Press button 21 whilst master switch 11 is switched on. LED 20 lights up. Look into the viewfinder and wait

until the red area of the aperture scale is next to the index mark.

The camera is now once again programmed for the fade-in.

Please avoid cross-fading on the first few feet of the film. The camera automatically rewinds a piece of film approximately 19 cm or 38 cm back into the Super-8 cartridge during lap dissolve operations. Obviously, there is no room left in the cartridge at the beginning or end of the film.

The film is folded several times in the cartridge when re-wound. In certain circumstances, the film may jam if it is of poor quality.

If this happens immediately disconnect the power supply from the motor by switching off the electrical master switch. Then, loosen the cartridge in the camera's cartridge compartment. Now reconnect the power supply to complete the cross-fading programme you started before the fault occurred. Now reinsert the cartridge and close the cover. Do not

start any more cross-fading programmes with this cartridge. In future, only use films that you know are suitable for cross-fading.

Malfunctions are extremely rare if you use a 60 m cartridge.

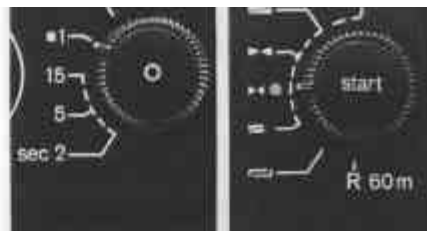

You must clear the programming if you wish to check the lighting conditions after a fade-out with a subsequent programmed fade-in or after the first phase of a lap-dissolve.

You can delete the programming by turning switch 31 from the «red dot» marking to  1 and then back to the «red dot» marking. LED 20 will be extinguished.

You can now read off the light measurement on the scale in the viewfinder and check whether or not the light is sufficient for the next scene.

Before shooting your next scene, you will have to restore the second phase of the fade-out, fade-in or cross-fade. With the master switch 11 switched on, press button 21. The LED 20 will light up. Look into the viewfinder and wait until the red area of the aperture scale is next to the index mark.

Your camera is now once again programmed for fade-in.

In the case of double exposure, two scenes are exposed one on top of the other.

You must close the lens diaphragm by one  $f$ /stop in order to double-expose two scenes. If you forget to do this, the film will become overexposed!

One condition for double exposure is that both scenes should be equally visible and that both scenes should have the same brightness values.

However, if only one third of one scene and two of the second scene is to be visible, you must close the lens diaphragm by  $1\frac{1}{2}$   $f$ /stops for normal exposure and, in the second case, the lens diaphragm must be closed by  $1\frac{1}{2}$   $f$ /stops.

In this case, the contrast of both scenes play an important role. For this reason, it is only possible to give average values. Try out all the various different possibilities with an occasional test.

When filming with 15 m cartridges, please avoid double exposures on the first and last few feet of film. The camera rewinds the film

back into the Super-8 cartridge. There is then no room in the cartridge at the beginning and at the end of the film.

When shifted back in this way, the film is folded several times in the cartridge. If the film is of poor quality or has deteriorated, after a long period of storage, it may jam in the cartridge.

If this happens immediately disconnect the power supply to the motor by switching off the electrical master switch 11. Then loosen the cartridge in the camera's cartridge compartment. Now reconnect the power supply in order to complete the initiated cross-fading programme. Now reinsert the cartridge and close the cover. Do not programme any more double exposures or lap dissolves with this cartridge. In future, only use films for double exposures and lap dissolves which suitable for this purpose.

Malfunctions rarely occur with 60 m cartridges. However, make sure that you do not wind the film back to the very beginning!



For preprogrammed double exposures with 15 m film cartridges, set switch 25 to «»-position. Manually close the aperture by one  $f$ /stop (refer to page 20) or turn knob 37 individual adjustment by three click-stop settings to the right (—), corresponding to one  $f$ /stop. Then depress button 21 and the release 15 at the same time.

After automatic winding back of the film, lasting approximately 5 s (90 frames), the camera will stop on its own. During this time, the action signal in the handgrip and the camera winding pilot light in the viewfinder will not flash. Watch the aperture scale in the viewfinder. Here, you can check that the aperture completely closes when the red area moves past the index mark. In «automatic mode», the aperture will open after the film has again been rewound automatically for about 5 s (90 frames). In «manual mode», you must «manually» set the desired aperture before beginning the second double exposure phase.

With 15 m cartridges, please make sure that the camera automatically rewinds the film after the first phase of programmed double

33

exposure. Make sure that this takes place «3 seconds» after the first phase of cross-fading or double exposure.

This delay is necessary to ensure that the aperture closes before rewinding.

The master switch 11 *must* be kept switched on until rewinding is complete.

Then wait about 3 s before starting the second part of double exposure.

The camera is now ready for the second phase of double exposure.

Important: for this purpose, *only* depress the release 15 or 29!

Exactly the same piece of film, on which the first phase of double exposure took place, will be double-exposed.

This will take place as long as you depress release 15 or 29 and will stop automatically after about 5 s (90 frames).

The programmed end point of the second phase of double exposure is deleted if you wish to change the accumulator or if you switch off the main switch 11 between programmed double exposures.

This is also the case if, before starting the second phase, you turn switch 25 from the position «» to one of the four positions for fade-in, fade-out and lap-dissolve.

When you are carrying out double exposures, the sound is also recorded double and thus the recording is scarcely of any value.

Therefore, before a double exposure, you must decide whether you would like to record the sound of the first or second phase. Before beginning the phase without sound recording, set switch 39 to 0.



Set switch 25 to its «» for preprogrammed double exposure with a 60 m cartridge. Manually close the aperture by one  $f$ /stop (refer to page 20) or turn knob 37 for individual adjustment by three click-stop settings to the right (—), corresponding to one  $f$ /stop.

Now depress button 21 and the release 15 at the same time. The first phase of double exposure will run as long as you keep the release 15 depressed.

The camera will stop once you let go of the release 15. Watch the aperture scale in the viewfinder. Here, you can check that the aperture is fully closed when the red area is next to the index mark. The film will now be automatically rewound depending on the length of time you depressed the release 15 in order to programme this procedure.

The aperture opens up when using, «automatic mode». In «manual mode», you must manually set the aperture to the desired  $f$ /stop before the second phase of the double exposure.

34





Please note that, in the case of 60 m cartridges, the camera automatically rewinds the film after the first phase of lap dissolve and programmed double exposure. The film is rewound for -3 seconds- after the first phase of lap dissolve or double exposure.

This delay is necessary to ensure that the aperture has closed before the film is rewound.

The master switch 11 *must* be kept switched on until rewinding is complete.

Then wait for about 3 seconds before starting the second phase of double exposure.

The camera is now ready for this second phase.

**Important:** for this purpose *only* depress release 15 or 29!

Exactly the same piece of film, which was exposed for the first phase, will now be double-exposed.

The camera runs as long as you depress the release button 15 or 29 and stops automatically at the point at which the first phase of the double exposure was completed. Any number of intermediate stops are possible beforehand. The double exposure is now completed.

Please remember that you must once again open the automatic exposure mechanism by one f/stop or switch over from -manual mode- to -automatic mode-.

The programming for the end of the second double exposure phase will be deleted if you replace the accumulator between two phases. This is also the case if you turn switch 25 from the -R 60- setting to one of the four settings for fade-out, fade-in and cross-fade before starting the second phase.

If you would like to try out the camera without a film, in order to get to know its functions, you must open the cartridge compartment cover for 60 m cartridges 33.

The sound is automatically doubly recorded during double exposures. If you wish to prevent this, turn switch 39 to -0- in the double exposure phase in which you would like to erase the sound.

For subsequent programmed double exposure with a -60 m cartridge-, turn switch 25 to the -R 60 m- setting. Manually close the aperture by one f/stop (refer to page 20), or turn knob 37 for individual adjustment by three click-stop settings to the right (-), corresponding to one f/stop.

Now, *only* depress button 21 for as long as you would like the double exposure.

Watch the aperture scale in the viewfinder. Here, you can check that the aperture closes completely when the red area is next to the index mark. A length of film is automatically rewound which corresponds to the amount of time you operated button 21 to programme this procedure.

In -automatic mode-, the aperture opens up. In -manual mode-, you must set the aperture manually to the desired f/stop before starting the second phase of double exposure.

35

Then wait for about three seconds before starting the second phase.

The camera is now ready for the second phase of double exposure.

**Important:** for this purpose, *only* depress the release 15 or 29!

Exactly the same piece of film, on which the first phase was carried out, will be double-exposed.

The camera runs as long as you depress the release button 15 or 29 and stops automatically at the point at which the first phase of the double exposure was completed. Any number of intermediate stops are possible beforehand.

This now completes double exposure.

Please remember that you must once again open the automatic exposure mechanism by one f/stop or switch over from -manual mode- to -automatic mode-.

The programming for the end of the second double exposure phase will be wiped out if you replace the accumulator between programmed double exposures.

This is also the case if you turn switch 25 from its -R 60- setting to one of the four settings for fade-out, fade-in and cross-fade before starting the second phase.

The sound is doubly recorded during double exposure. If you wish to prevent this, turn switch 39 to -0- in the double exposure phase in which you would like to prevent sound recording.

If you would like to try out the camera without a film, in order to get to know its functions, you must open the cartridge compartment cover for 60 m cartridges 33.

## Section 4: Sound filming

On film the picture is the first consideration and, as a rule, the sound accompanying the film has the same function as the text accompanying a photograph in a magazine. The purpose of the sound is to provide additional information and thus to enable faster and better comprehension of the messages you are trying to convey. Additional information can also consist of a musical background. We will return to this subject on page 49 when we introduce the Braun Visacoustic sound film projector.

Original sound is always irreplaceable when someone stands in front of your lens and talks, even if it is only a baby crying.



Screw the microphone bracket into the threaded mount on the camera by means of the knurled screw on the bracket.



The microphone included has a directional characteristic and an impedance of 2000 Ohms. You can also use any other low or medium impedance microphone (200 to 5000 Ohms) which is wired in accordance with DIN 45 594. You will find a circuit diagram at the end of section four which will help you in your search for the right microphone.

You will find further Braun accessory microphones in the list of accessories on Pages 46 and 47. The list also features an adapter lead which you will need if you want to connect two microphones.

Insert the plug of the microphone lead into socket 38.

We do however recommend one thing: do not allow your filming concept to become confused by too much sound. Do not forget that you can **always** polish up, supplement or even replace all sound recordings which have not turned out particularly well. However, this is not the case with your filming.

37



Shift the slide switch 39 to «mic high» (red dot marking).

If, when using a sound film cartridge, you would like to prevent sound recording for any particular reason, turn slide switch 39 to the mid-position «0». This will switch off the camera's audio amplifier.



A microphone mounted on the camera is the best solution for one-man operation. However, in principle you should always try to place the microphone as near as possible to the sound source.

The microphone will always be directed towards your film subjects if you leave it on the telescopic mount on the microphone bracket 5 of the camera.

The mount with the camera can be extended by about 40 cm. In order to do this, pull on the capsule of the microphone.

Important: you will only obtain optimum sound recordings with the microphone completely extended!



In special circumstances, you can also mount the telescopic microphone *below* the camera (e. g., if you have inserted a 60 m cartridge).

Unscrew the knurled screw 3 on the microphone mount of the camera.

Turn the mount with the microphone round.

With the large knurled screw 3, screw the mount, horizontally to the camera, into the smaller of the two tripod threads on the camera base.

Place the wind shield onto the microphone capsule.

38



Screw the microphone onto a tripod if you would like to have a greater distance between the microphone and camera.

Screw the tripod screw into the thread on the microphone bracket.

Now place the wind shield onto the microphone capsule.

Refer to the summary of accessories for the -power mic, MD 1000- extension lead if your microphone lead is not long enough.



Hold the microphone (for example during an interview) in your hand.

You can remove the microphone from the clamp on its bracket. If you wish to replace the microphone, it is easier to press the microphone mount sideways into the clamp. Make sure that the white wedge mark on the microphone body is next to the edge of the clamp.

Always place the wind shield onto the microphone capsule.



Now connect the extension lead.

During recording, please avoid hitting the microphone or its lead. Hold the microphone steadily and do not rub it.

39



To a certain extent, the earphone is a «sound-finder». In the same way as the viewfinder, it concentrates your attention on the film subjects.

Connect the earphone to socket 40. Hook the earphone onto your ear.

The earphone's clip can be turned around if you wish to hook it on your other ear. Switch on the master switch 11 and push the slide switch 39 to «mic» to use the earphone.



You can also connect commercially available headphones with an impedance of at least 1.5 kOhms to socket 40.



In most cases, you can leave the recording level control to the infinitely variable automatic system when using the microphone.

For outdoor recordings, set switch 30 to «high».

For indoor recordings, set switch 30 between high and low. In this case, sound recording is slightly attenuated to prevent the camera's running noise from being recorded during indoor scenes. To record speakers' voices in the presence of extreme background noise, set switch 30 to low.

Keep your eye on the recording level indicator.

40

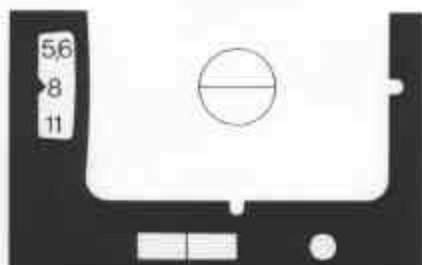

Activate the master switch 11.

Look into the viewfinder to check the recording level.

No sound recording is being made if the signal does not light up. If this happens, reduce the distance between the microphone and sound source. Do not forget that you can separate the microphone from the camera.

The minimum sound recording level has been reached if the left-hand side of the green signal occasionally lights up. You will then have a quiet sound recording.

The normal sound recording level has been reached if the complete green signal area occasionally lights up.

If the red signal below the viewfinder image lights up, the limiter sets in and prevents overmodulation.



The automatic sound recording level system always sets itself to the loudest sound source. Weak noises only reach the proper recording level after a slight delay.

For example: if you have a pause in an interview, the background noises will not be heard until a few seconds later.

You can use the manual recording level control if you want to prevent automatic level boosting of background noises.

For this purpose, set switch 27 to the «man» setting. You can then smoothly modulate the recording level with switch 30. Turn it towards «high» until the light signals in the viewfinder display the correct recording level. All the green signal area must occasionally light up.

The built-in filter prevents brief overmodulation. Turn switch 30 somewhat in the direction of «low» if you see that the red signal frequently lights up.



You can interrupt sound recording at any time while shooting a scene.

In order to do this, press button 30.

Keep your finger on the button for the amount of time you would like to interrupt the sound.

The sound recording will be faded in again when you release the button. Interruptions in sound recording cannot be detected in the earphone.

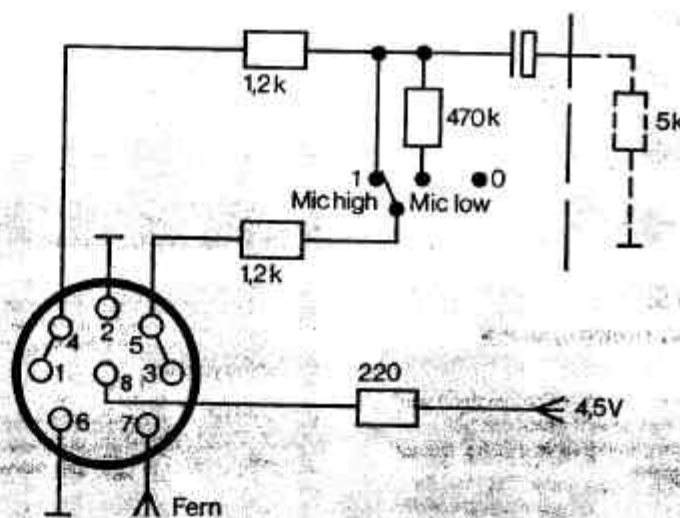

## Technical data of your camera's audio amplifier

Sensitivity of microphone input high  
Referred to 0 db recording level  
aut high setting 0.2 mV-25 mV<sub>rms</sub>  
aut low setting 1.5 mV - 50 mV<sub>rms</sub>

mic input  
aut high setting 10 mV - 1.5 V<sub>rms</sub>  
aut low setting 75 mV - 2.5 V<sub>rms</sub>

Input impedance mic low 470 kOhms  
Input impedance mic 5 kOhms  
RF bias 55 kHz  
Signal-to-noise ratio 46 dB measured according to DIN

Harmonic distortion at full recording level 0.2%  
Response delay of automatic system 5 - 20 s  
Frequency response 80 Hz - 20 kHz ± 3 DB  
Wow and flutter ≤ 0.4%

Technical changes reserved.



## Section 6: Accessories

For your Nizo camera, you can obtain a supplementary lens for special, extreme close-ups.

This supplementary lens helps prevent frightening insects away. With its other perspectives, this lens is a clear alternative to your camera's macro system.



It will only be necessary to use filters in exceptional circumstances. So-called clip-on filters are recommended. This type of filter guarantees vignette-free shots without covered-up edges). The Braun range comprises the following types:

UV filter including backlight filter  
Part No. 7 976 800 for Nizo 6080  
Part No. 7 979 900 for Nizo 6056  
Skylight filter including backlight filter  
Part No. 7 977 900 for Nizo 6080  
Part No. 7 980 900 for Nizo 6056  
Gray filter N.D. 4 x  
Part No. 7 978 900 for Nizo 6080  
Part No. 7 981 900 for Nizo 6056



The supplementary lens Nizo ultra-wide III for the Nizo 6080 gets three times as much into the picture.

When you screw these supplementary lenses onto the camera lens, the focal length is reduced by 4 mm, the depth of the focus begins practically at the front lens and the angle of view is increased to 80°.

When using the Nizo ultra-wide lens, the camera is set to «macro».

The Nizo ultra-wide I and III lens attachments are used in the macro range with the UWL marking set to its full position.

Nizo ultra-wide lens I  
Part No. 7 707 900  
for Nizo 6056

Nizo ultra-wide lens III  
Part No. 7 712 900  
for Nizo 6080

Close-up lens	Setting range	Minimum image field	Scale
<b>Nizo 6056:</b>			
Nizo NL 52/58 Part No. 7 986 900	0,33—0,24m	22 x 16 mm	1:4,1
<b>Nizo 6080:</b>			
Nizo NL 67/77 Part No. 7 985 900	0,50—0,37 m	15 x 19 mm	1:4,8

45



With the Nizo remote release, you can also appear in front of the camera without having to enlist the aid of an assistant.

For trick shots with manual single-frame shooting, the remote release can also be used instead of a cable release.

You can also hide the camera if you use the remote release.

The Nizo remote release provides 10 m of control cable on a drum with release button.

Up to ten of these releases can be connected in series.

Part No. 7 669 900



The dynamic omnidirectional hand microphone MO 100 can also be used. It has a remote control button and, in the same way as the Nizo remote control, you can start and stop the camera motor with this button. In this way, you literally have the camera control in your hand.

«Omnidirectional characteristic»  
Frequency response 100 to 12,000 Hz;  
Impedance at 1000 Hz = 500 Ohms ± 20%;  
Sensitivity at 1000 Hz = 0.25 mV/μb.

The extension lead «start mic MO 100» can be used with this microphone.

Part No. 7 693 900



If you want a second microphone, you can obtain as an accessory the same Electret microphone MD 1000 that you received with the camera.

«Cardioid» characteristic  
Frequency response 70 to 20,000 Hz;  
impedance at 1000 Hz = 2 kOhms;  
Sensitivity at 1000 Hz = 0.35 mV/μb.

The «power mic» MD 1000 extension lead can be used with this camera.

Part No. 7 706 900



The Electret tubular directional microphone MSD 1000 has an even greater directional characteristic and can be used as a second microphone.

It has special switch settings for music or speech recordings.

-Lobe- characteristic  
Frequency response 20 to 20,000 Hz  
Impedance at 1000 Hz = 600 Ohms  
Sensitivity at 1000 Hz = 0.4 mV/ $\mu$ b.

Part No. 7 710 900



The bag for your Nizo camera is tailor-made and accommodates the camera including the mounted telescopic directional microphone or with an inserted 60 m cartridge. The bag also provides space for several 15 m or one 60 m cartridge and a special compartment for these operating instructions. Therefore, ask your dealer for this special carrying bag.

Part No. 7 726 900



The Braun compendium opens up all sorts of filmmaking possibilities which will make your films more sophisticated and more interesting to watch.

The included masks and caches provide a multitude of possibilities for tricks and effects.

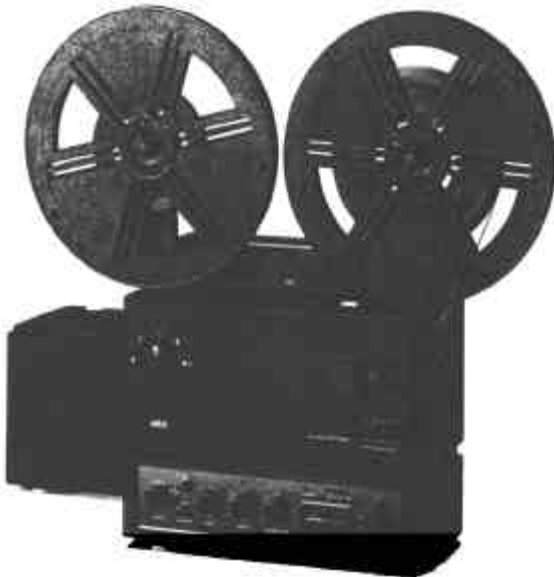

#### **Automatic sound gap**

The Braun Visacoustic 2000 digital mixes your sound automatically. This is how it is done:

\*erase all the original sound recordings on track 1 which you do not like. Then record some suitable music on track 2. During playback, the automatic sound gap system will reduce the level on track 2 as long as there is original sound on track 1. Once the recording on track 1 ends, the level of the music on track 2 will be raised once again. Nothing happens to the irreplaceable original recordings you want to keep on track 1. Of course, you can also do this if you want to add magnetic sound tracks to a silent movie: you can record your commentaries on track 1 and you can dub some fitting music onto track 2. The automatic sound gap system will ensure that the music does not over-power on your commentaries.

#### **Duoplay**

The two sound channels of the BRAUN Visacoustic 2000 digital can either play back the sound information on the two magnetic sound tracks separately or together and, stereophonic dubbing of music is no problem. However, if you only want to record music on one track and your commentary, for example, on the other, or if you want any other combination of various types of sound information, you can play back both tracks together. This is called duoplay.

#### **Playback**

If you dub your film in accordance with the duoplay method, it will be necessary to monitor one track whilst you are recording a new sound information on the other track. This is called playback. The complete separation of both sound channels in the Braun Visacoustic 2000 digital permits you to switch one channel to recording mode and the other to playback. In this way, you can monitor the existing sound recording via a loudspeaker or headphones and you can mix it with the new recording at the required volume.

#### **Automatic dubbing system**

For even more sophisticated dubbing, the Braun Visacoustic 2000 digital has a synchronous, programmable automatic dubbing system which enables -hard- or normal fade-ins and fade-outs. For this purpose, the (remotely controlled) tape recorder connected for dubbing is started and stopped automatically. The dubbing operation is synchronously preprogrammed digitally on the sixdigit digital frame counter of the Braun Visacoustic 2000 digital with LED display. You can determine exactly the beginning and end of a dub-in at the push of a button.

Your valuable original sound or other recordings are also protected against inadvertent erasure if you want to record sound on track 1 at a later date. You can preprogram exactly the start and finish of a recording and you can also determine whether fade-ins and fade-outs are to be -hard- or normal. You can even combine -smooth- and -hard- fade-ins and fade-outs.

49

#### **Multiplay**

This feature of the Braun Visacoustic enables track-to-track dubbing without a loss of image-synchronisation (as is the case with a good tape recorder). For example, you can record music, background noises and commentaries onto track 2 and then add them to the original sound on track 1 after you have checked the quality of your recordings.

#### **Perfect sound film**

The Braun Visacoustic 2000 digital is a valuable sound recording assistant which will help you to make your films worth listening to. For playback, you have the amplifiers with 20 W continuous music power, high grade closed speaker systems with wide-band loud speakers and — on the optical side — a first-class top quality lens from Schneider-Kreuznach.

## Part 7: Having trouble? Its probably not as bad as you think.

The Braun specialists have done everything to make your *Nizo* robust and easier to use. Nevertheless, if you encounter troubles, then this short summary should help you to find the reason for minor faults, especially in the initial period while you are getting used to the camera. If you have a fault, please spend a little time going through this checklist.

### Camera does not run after charging batteries

*Possible cause:*

You tried to charge the accumulator with the main switch in the on position.

*Remedy:*

Turn-off the main switch during charging.

---

### Camera runs jerkily

*Possible cause:*

One of the six NC-cells in the accumulator box is discharged or defective.

*Remedy:*

Charge the accumulator box or have it checked at your local service point.

---

### Camera does not start after charging

*Possible cause:*

The cross-fade programme was started by electrical pulses in the mains supply during charging.

*Remedy:*

Remove the accumulator box from the camera for at least 20 seconds.

---

### Camera does not start

*Possible cause:*

Main switch not turned on.

*Remedy:*

Turn on main switch.

The start button for fade-out/fade-in and lap-dissolve was operated before release (programming entered!).  
The LED 20 lights up.

Clear the programming by turning switch 31 from the «red dot» marking to «■» and return the switch to the «red dot» marking.  
The LED 20 is extinguished.

NC-accumulators are discharged.

Charge the accumulators.

---

### Current consumption too high

*Possible cause:*

Main switch was not turned off after use.

*Remedy:*

Turn on the main switch only when the camera is to be used.

Low ambient temperature during filming.

At low ambient temperatures, the accumulators do not produce full power. Fit replacement accumulator box, which should be at approximately body temperature.

---

### Aperture indication does not function

*Possible cause:*

Main switch not turned on.

*Remedy:*

Turn on main switch.

Automatic exposure device is switched off.

Turn aperture adjustment knob to «autom.».

---

### Underexposure

*Possible cause:*

Backlight during filming.

*Remedy:*

Check existing films. In this situation, depress the «+» one pushbutton on the camera.

---

### Underexposure when camera is switched to 54 frames/sec.

*Possible cause:*

Insufficient light.

*Remedy:*

Check the exposure indicator. Remember the aperture offset of 1.5.



#### Underexposure

*Possible cause:*

Excessive contrast in the subject.

*Remedy:*

Check sample films. Set the aperture manually.

Automatic aperture selection was switched off.

Turn the aperture knob to «autom.»

---

#### Camera runs continuously

*Possible cause:*

Function selection switch set to continuous operation.

*Remedy:*

Turn switch to normal position (red dot).

---

#### Vignetting of film exposure (edges blanked off)

*Possible cause:*

Wide angle adapter was fitted to a camera for which it was not designed.

*Remedy:*

Use only original Braun Nizo wide angle adapters.

(At short focal lengths)

An incorrect close-up lens was used together with a sun shade with insufficiently large opening.

Use original Braun Nizo close-up lenses with special sun shades.

(With short focal lengths)

Filter with high edge and sun shade used simultaneously.

Use original Braun Nizo filters and sun shades.

---

#### Incorrect focusing

*Possible cause:*

View-finder not adjusted, or incorrectly adjusted.

*Remedy:*

Check the view-finder adjustment as described in the operating instructions.

#### Out of focus during zoom operation in the tele-photo range

*Possible cause:*

The distance was not set at the longest focal length before starting filming.

*Remedy:*

Adjust distance with longest focal length.

Sudden lack of focus when zooming in the wide angle range.

Camera was set to «macro»; switch off the macro range for exposures at normal distances.

---

#### No automatic zoom adjustment

(Only Nizo 6080)

*Possible cause:*

The adjusting wheel on the vario-section is set to «0», thus disconnecting the zoom motor.

*Remedy:*

Set the adjusting wheel to its normal position.

---

#### Picture moves off centre during zoom operation

*Possible cause:*

Camera was not correctly aligned at a short focal length.

*Remedy:*

Align the camera at the longest focal length.



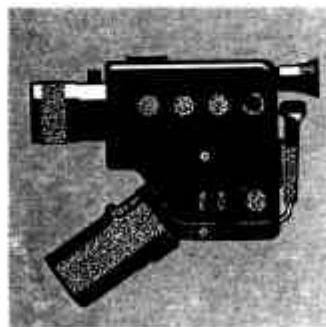
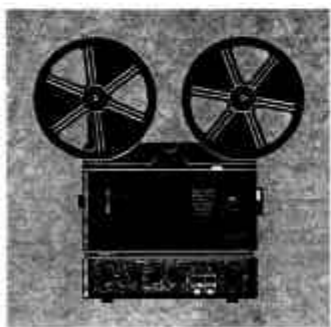
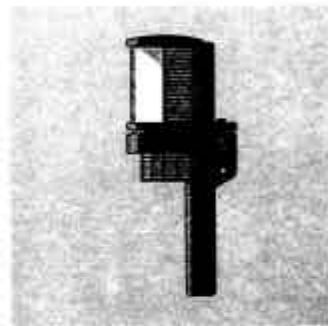
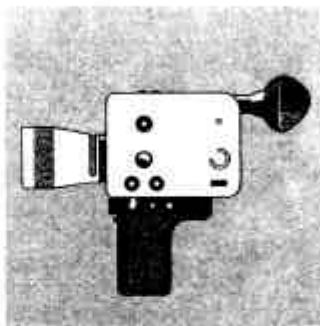
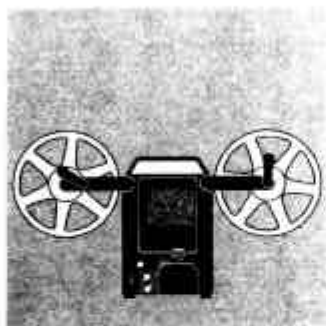

**Braun  
Film-  
und  
Foto-  
Technik**